

# LUXEON 2835 Architectural

Perfected performance, built on a proven legacy

LUXEON 2835 Architectural is a collection of compact devices that allows for design freedom and provides a superior overall system solution when a project requires high lumen output and good efficacy. With an industry standard footprint, the LUXEON 2835 Architectural is the perfect upgrade for other 2835 products and other common mid power offerings. LUXEON 2835 Architectural is color targeted for application needs and delivers efficacy and reliability for a variety of applications.



## FEATURES AND BENEFITS

Various configurations of voltage and die count to meet a wide range of application requirements

Industry standard footprint for drop-in replacement designs

Maximum drive current of up to 480mA allows for reduction of LED count

6V and 9V hot-color targeting and 1/9<sup>th</sup> micro-color binning enable tight color control

2-, 3-, 4- and 5-step MacAdam ellipse color kits available

## PRIMARY APPLICATIONS

Panel / Soft Lights

Linear

Troffers

Downlights

Retrofit Lamps

[More...](#)

# Table of Contents

|   |           |
|---|-----------|
| <b>General Product Information</b> .....          | <b>2</b>  |
| Product Test Conditions .....                     | 2         |
| Part Number Nomenclature .....                    | 2         |
| Lumen Maintenance .....                           | 2         |
| Environmental Compliance .....                    | 2         |
| <b>Performance Characteristics</b> .....          | <b>3</b>  |
| Product Selection Guide .....                     | 3         |
| Optical Characteristics .....                     | 6         |
| Electrical and Thermal Characteristics .....      | 6         |
| <b>Absolute Maximum Ratings</b> .....             | <b>7</b>  |
| <b>Characteristics Curves</b> .....               | <b>8</b>  |
| Spectral Power Distribution Characteristics ..... | 8         |
| Light Output Characteristics .....                | 12        |
| Forward Current Characteristics .....             | 14        |
| Radiation Pattern Characteristics .....           | 16        |
| <b>Product Bin and Labeling Definitions</b> ..... | <b>17</b> |
| Decoding Product Bin Labeling .....               | 17        |
| Luminous Flux Bins .....                          | 18        |
| Color Bin Definition .....                        | 20        |
| Forward Voltage Bins .....                        | 34        |
| <b>Mechanical Dimensions</b> .....                | <b>35</b> |
| <b>Reflow Soldering Guidelines</b> .....          | <b>36</b> |
| JEDEC Moisture Sensitivity .....                  | 36        |
| Solder Pad Design .....                           | 37        |
| <b>Packaging Information</b> .....                | <b>37</b> |
| Pocket Tape Dimensions .....                      | 37        |
| Reel Dimensions .....                             | 38        |

# General Product Information

## Product Test Conditions

LUXEON 2835 Architectural LEDs are tested with a 20ms monopulse of driving current specified below at a junction temperature,  $T_j$ , of 25°C unless otherwise noted. Forward voltage and luminous flux are binned at a  $T_j$  of 25°C. LUXEON 2835E 6V, LUXEON 2835E 9V and LUXEON 2835C 6V color is hot-targeted at a  $T_j$  of 85°C and LUXEON 2835 HE 3V, LUXEON 2835N 3V, LUXEON 2835E 3V, LUXEON 2835C 3V and LUXEON 2835C 3V TVS color is cold-targeted at a  $T_j$  of 25°C.

60mA/100mA – LUXEON 2835E

120mA – LUXEON 2835C

65mA – LUXEON 2835 HE, LUXEON 2835N 3V

65mA (50ms) – LUXEON 2835 HE ended with 0Kx and associated parts

## Part Number Nomenclature

Part numbers for LUXEON 2835 Architectural follow the convention below:

L 1 2 8 – **A A B B C D** 3 5 0 0 0 **E F**

Where:

- A A** – designates nominal ANSI CCT (18=1800K, 22=2200K, 27=2700K, 30=3000K, 35=3500K, 40=4000K, 50=5000K, 57=5700K, 65=6500K)
- B B** – designates minimum CRI (80=80CRI and 90=90CRI)
- C** – designates product line (E, C, N, H, etc)
- D** – designates voltage of the part (A=3V, B=6V and C=9V)
- E** – designates Lumileds internal code (B, H, T, K, etc)
- F** – designates Lumileds internal code (1, 2, 3, etc.=shares the same base part)

Therefore, the following part number is used for a LUXEON 2835C 3000K 80CRI, 6V LED:

L 1 2 8 – **3 0 8 0 C B** 3 5 0 0 0 0 **1**

## Lumen Maintenance

Please contact your local Sales Representative or Lumileds Technical Solutions Manager for more information about the long-term performance of this product.

## Environmental Compliance

Lumileds LLC is committed to providing environmentally friendly products to the solid-state lighting market. LUXEON 2835 Architectural is compliant to the European Union directives on the restriction of hazardous substances in electronic equipment, namely the RoHS Directive 2011/65/EU and REACH Regulation (EC) 1907/2006. Lumileds LLC will not intentionally add the following restricted materials to its products: lead, mercury, cadmium, hexavalent chromium, polybrominated biphenyls (PBB) or polybrominated diphenyl ethers (PBDE).

# Performance Characteristics

## Product Selection Guide

Table 1. Product performance of LUXEON 2835 Architectural at specified test conditions.

| VOLTAGE | PRODUCT      | NOMINAL CCT <sup>[1]</sup> | MINIMUM CRI <sup>[2, 3]</sup> | LUMINOUS FLUX <sup>[2, 3]</sup> (lm) |         | TYPICAL LUMINOUS EFFICACY (lm/W) | TEST CURRENT (mA)  | PART NUMBER        |
|---------|--------------|----------------------------|-------------------------------|--------------------------------------|---------|----------------------------------|--------------------|--------------------|
|         |              |                            |                               | MINIMUM                              | TYPICAL |                                  |                    |                    |
| 3V      | LUXEON 2835E | 2700K                      | 80                            | 23.0                                 | 27.6    | 158.6                            | 60                 | L128-2780EA3500001 |
|         |              | 3000K                      | 80                            | 24.0                                 | 28.6    | 164.4                            | 60                 | L128-3080EA3500001 |
|         |              | 3500K                      | 80                            | 24.0                                 | 29.6    | 170.1                            | 60                 | L128-3580EA3500001 |
|         |              | 4000K                      | 80                            | 26.0                                 | 30.1    | 173.0                            | 60                 | L128-4080EA3500001 |
|         |              | 5000K                      | 80                            | 26.0                                 | 30.1    | 173.0                            | 60                 | L128-5080EA3500001 |
|         |              | 5700K                      | 80                            | 26.0                                 | 30.1    | 173.0                            | 60                 | L128-5780EA3500001 |
|         |              | 6500K                      | 80                            | 26.0                                 | 29.9    | 171.8                            | 60                 | L128-6580EA3500001 |
|         |              | 2700K                      | 90                            | 19.0                                 | 23.5    | 135.1                            | 60                 | L128-2790EA3500001 |
|         |              | 3000K                      | 90                            | 20.0                                 | 24.8    | 142.5                            | 60                 | L128-3090EA3500001 |
|         |              | 3500K                      | 90                            | 20.0                                 | 25.7    | 147.7                            | 60                 | L128-3590EA3500001 |
|         |              | 4000K                      | 90                            | 21.0                                 | 26.3    | 151.1                            | 60                 | L128-4090EA3500001 |
|         |              | 5000K                      | 90                            | 21.0                                 | 26.3    | 151.1                            | 60                 | L128-5090EA3500001 |
|         |              | 5700K                      | 90                            | 21.0                                 | 26.3    | 151.1                            | 60                 | L128-5790EA3500001 |
|         |              | 6500K                      | 90                            | 21.0                                 | 26.0    | 149.4                            | 60                 | L128-6590EA3500001 |
|         |              | LUXEON 2835C               | 2700K                         | 80                                   | 49.0    | 58.2                             | 161.7              | 120                |
|         | 3000K        |                            | 80                            | 51.0                                 | 60.2    | 167.2                            | 120                | L128-3080CA3500001 |
|         | 3500K        |                            | 80                            | 53.0                                 | 61.2    | 170.0                            | 120                | L128-3580CA3500001 |
|         | 4000K        |                            | 80                            | 55.0                                 | 63.8    | 177.2                            | 120                | L128-4080CA3500001 |
|         | 5000K        |                            | 80                            | 55.0                                 | 63.8    | 177.2                            | 120                | L128-5080CA3500001 |
|         | 5700K        |                            | 80                            | 55.0                                 | 63.8    | 177.2                            | 120                | L128-5780CA3500001 |
|         | 6500K        |                            | 80                            | 55.0                                 | 63.8    | 177.2                            | 120                | L128-6580CA3500001 |
|         | 2700K        |                            | 90                            | 42.0                                 | 49.8    | 138.3                            | 120                | L128-2790CA3500001 |
|         | 3000K        |                            | 90                            | 42.0                                 | 51.9    | 144.2                            | 120                | L128-3090CA3500001 |
|         | 3500K        |                            | 90                            | 44.0                                 | 53.5    | 148.6                            | 120                | L128-3590CA3500001 |
|         | 4000K        |                            | 90                            | 46.0                                 | 54.6    | 151.7                            | 120                | L128-4090CA3500001 |
|         | 5000K        |                            | 90                            | 46.0                                 | 54.6    | 151.7                            | 120                | L128-5090CA3500001 |
|         | 5700K        |                            | 90                            | 46.0                                 | 54.6    | 151.7                            | 120                | L128-5790CA3500001 |
|         | 6500K        |                            | 90                            | 46.0                                 | 54.6    | 151.7                            | 120                | L128-6590CA3500001 |
|         | LUXEON 2835N |                            | 1800K                         | 80                                   | 21.9    | 23.3                             | 130.3              | 65                 |
|         |              | 2200K                      | 80                            | 26.6                                 | 28.3    | 158.3                            | 65                 | L128-2280NA3500001 |
| 2700K   |              | 80                         | 30.3                          | 32.5                                 | 181.8   | 65                               | L128-2780NA3500001 |                    |
| 3000K   |              | 80                         | 32.3                          | 34.4                                 | 192.4   | 65                               | L128-3080NA3500001 |                    |
| 3500K   |              | 80                         | 33.7                          | 35.9                                 | 200.8   | 65                               | L128-3580NA3500001 |                    |
| 4000K   |              | 80                         | 34.3                          | 36.5                                 | 204.2   | 65                               | L128-4080NA3500001 |                    |
| 5000K   |              | 80                         | 34.3                          | 36.5                                 | 204.2   | 65                               | L128-5080NA3500001 |                    |
| 5700K   |              | 80                         | 34.3                          | 36.5                                 | 204.2   | 65                               | L128-5780NA3500001 |                    |
| 6500K   |              | 80                         | 33.7                          | 35.9                                 | 200.8   | 65                               | L128-6580NA3500001 |                    |
| 1800K   |              | 90                         | 18.0                          | 19.1                                 | 106.9   | 65                               | L128-1890NA3500001 |                    |
| 2200K   |              | 90                         | 23.1                          | 24.6                                 | 137.6   | 65                               | L128-2290NA3500001 |                    |
| 2700K   |              | 90                         | 26.2                          | 27.9                                 | 156.1   | 65                               | L128-2790NA3500001 |                    |
| 3000K   |              | 90                         | 27.3                          | 29.0                                 | 162.2   | 65                               | L128-3090NA3500001 |                    |
| 3500K   |              | 90                         | 28.4                          | 30.2                                 | 169.0   | 65                               | L128-3590NA3500001 |                    |
| 4000K   |              | 90                         | 29.3                          | 31.2                                 | 174.5   | 65                               | L128-4090NA3500001 |                    |
| 5000K   | 90           | 29.3                       | 31.2                          | 174.5                                | 65      | L128-5090NA3500001               |                    |                    |
| 5700K   | 90           | 29.3                       | 31.2                          | 174.5                                | 65      | L128-5790NA3500001               |                    |                    |
| 6500K   | 90           | 29.1                       | 31.0                          | 173.4                                | 65      | L128-6590NA3500001               |                    |                    |

Table 1 continued on next page.

- Correlated color temperature is cold-targeted at  $T_j=25^{\circ}\text{C}$  for 3V products (LUXEON 2835 HE, LUXEON 2835N 3V, LUXEON 2835E 3V, LUXEON 2835C 3V, and LUXEON 2835C 3V TVS). Correlated color temperature is hot-targeted at  $T_j=85^{\circ}\text{C}$  for 6V and 9V products (LUXEON 2835E 6V, LUXEON 2835E 9V, and LUXEON 2835C 6V).
- Luminous flux and CRI specs are based upon mounted package on highly reflective surface at  $T_j=25^{\circ}\text{C}$ . Typical CRI is approximately 2 points higher than the minimum CRI specified, but this is not guaranteed.
- Lumileds maintains a tolerance of  $\pm 2$  on CRI and  $\pm 7.5\%$  on luminous flux measurements.

Table 1. Product performance of LUXEON 2835 Architectural at specified test conditions, continued.

| VOLTAGE | PRODUCT        | NOMINAL CCT <sup>[1]</sup> | MINIMUM CRI <sup>[2, 3]</sup> | LUMINOUS FLUX <sup>[2, 3]</sup> (lm) |         | TYPICAL LUMINOUS EFFICACY (lm/W) | TEST CURRENT (mA) | PART NUMBER        |
|---------|----------------|----------------------------|-------------------------------|--------------------------------------|---------|----------------------------------|-------------------|--------------------|
|         |                |                            |                               | MINIMUM                              | TYPICAL |                                  |                   |                    |
| 3V      | LUXEON 2835 HE | 3000K                      | 70                            | 32.4                                 | 37.1    | 210.6                            | 65                | L128-3070HA35000B1 |
|         |                | 3500K                      | 70                            | 32.8                                 | 37.7    | 214.0                            | 65                | L128-3570HA35000B1 |
|         |                | 4000K                      | 70                            | 34.0                                 | 38.6    | 219.1                            | 65                | L128-4070HA35000B1 |
|         |                | 5000K                      | 70                            | 34.0                                 | 38.6    | 219.1                            | 65                | L128-5070HA35000B1 |
|         |                | 5700K                      | 70                            | 33.7                                 | 38.1    | 216.3                            | 65                | L128-5770HA35000B1 |
|         |                | 6500K                      | 70                            | 33.6                                 | 38.1    | 216.3                            | 65                | L128-6570HA35000B1 |
|         |                | 1800K                      | 80                            | 22.1                                 | 23.5    | 133.4                            | 65                | L128-1880HA35000B1 |
|         |                | 2200K                      | 80                            | 26.0                                 | 29.1    | 165.2                            | 65                | L128-2280HA35000B1 |
|         |                | 2700K                      | 80                            | 30.5                                 | 34.0    | 193.0                            | 65                | L128-2780HA35000B1 |
|         |                | 3000K                      | 80                            | 31.5                                 | 34.9    | 198.1                            | 65                | L128-3080HA35000B1 |
|         |                | 3500K                      | 80                            | 32.7                                 | 36.4    | 206.6                            | 65                | L128-3580HA35000B1 |
|         |                | 4000K                      | 80                            | 33.5                                 | 36.8    | 208.9                            | 65                | L128-4080HA35000B1 |
|         |                | 5000K                      | 80                            | 33.5                                 | 36.8    | 208.9                            | 65                | L128-5080HA35000B1 |
|         |                | 5700K                      | 80                            | 33.5                                 | 36.8    | 208.9                            | 65                | L128-5780HA35000B1 |
|         |                | 6500K                      | 80                            | 33.0                                 | 36.5    | 207.2                            | 65                | L128-6580HA35000B1 |
|         |                | 1800K                      | 90                            | 17.9                                 | 19.0    | 107.9                            | 65                | L128-1890HA35000B1 |
|         |                | 2200K                      | 90                            | 22.9                                 | 24.4    | 138.5                            | 65                | L128-2290HA35000B1 |
|         |                | 2700K                      | 90                            | 24.3                                 | 27.9    | 158.4                            | 65                | L128-2790HA35000B1 |
|         |                | 3000K                      | 90                            | 25.4                                 | 29.5    | 167.5                            | 65                | L128-3090HA35000B1 |
|         |                | 3500K                      | 90                            | 26.7                                 | 30.4    | 172.6                            | 65                | L128-3590HA35000B1 |
|         |                | 4000K                      | 90                            | 27.4                                 | 31.0    | 176.0                            | 65                | L128-4090HA35000B1 |
|         |                | 5000K                      | 90                            | 27.4                                 | 31.0    | 176.0                            | 65                | L128-5090HA35000B1 |
|         |                | 5700K                      | 90                            | 27.4                                 | 31.0    | 176.0                            | 65                | L128-5790HA35000B1 |
|         |                | 6500K                      | 90                            | 27.0                                 | 30.9    | 175.4                            | 65                | L128-6590HA35000B1 |
|         |                | 2700K                      | 95                            | 23.4                                 | 27.2    | 154.4                            | 65                | L128-2795HA35000B1 |
|         |                | 3000K                      | 95                            | 24.3                                 | 28.2    | 160.1                            | 65                | L128-3095HA35000B1 |
|         |                | 3500K                      | 95                            | 24.7                                 | 28.5    | 161.5                            | 65                | L128-3595HA35000B1 |
|         |                | 4000K                      | 95                            | 25.4                                 | 29.0    | 164.5                            | 65                | L128-4095HA35000B1 |
|         |                | 5000K                      | 95                            | 25.9                                 | 29.6    | 168.0                            | 65                | L128-5095HA35000B1 |
|         |                | 5700K                      | 95                            | 26.3                                 | 30.0    | 170.0                            | 65                | L128-5795HA35000B1 |
|         |                | 2700K                      | 70                            | 35.5                                 | 37.4    | 212.3                            | 65                | L128-2770HA35000H1 |
|         |                | 3000K                      | 70                            | 35.5                                 | 38.5    | 218.6                            | 65                | L128-3070HA35000H1 |
|         |                | 3500K                      | 70                            | 36.1                                 | 38.8    | 220.3                            | 65                | L128-3570HA35000H1 |
|         |                | 4000K                      | 70                            | 37.0                                 | 39.8    | 225.9                            | 65                | L128-4070HA35000H1 |
|         |                | 5000K                      | 70                            | 37.0                                 | 39.8    | 225.9                            | 65                | L128-5070HA35000H1 |
|         |                | 5700K                      | 70                            | 36.5                                 | 39.5    | 224.2                            | 65                | L128-5770HA35000H1 |
|         |                | 6500K                      | 70                            | 36.5                                 | 39.5    | 224.2                            | 65                | L128-6570HA35000H1 |
|         |                | 1800K                      | 80                            | 23.3                                 | 24.8    | 140.8                            | 65                | L128-1880HA35000H1 |
|         |                | 2200K                      | 80                            | 28.7                                 | 30.5    | 173.1                            | 65                | L128-2280HA35000H1 |
|         |                | 2700K                      | 80                            | 32.4                                 | 34.5    | 195.9                            | 65                | L128-2780HA35000H1 |
|         |                | 3000K                      | 80                            | 33.4                                 | 35.5    | 201.5                            | 65                | L128-3080HA35000H1 |
|         |                | 3500K                      | 80                            | 34.8                                 | 37.0    | 210.0                            | 65                | L128-3580HA35000H1 |
| 4000K   | 80             | 35.8                       | 38.1                          | 216.3                                | 65      | L128-4080HA35000H1               |                   |                    |
| 5000K   | 80             | 35.8                       | 38.1                          | 216.3                                | 65      | L128-5080HA35000H1               |                   |                    |
| 5700K   | 80             | 35.3                       | 37.5                          | 212.9                                | 65      | L128-5780HA35000H1               |                   |                    |
| 6500K   | 80             | 34.8                       | 37.0                          | 210.0                                | 65      | L128-6580HA35000H1               |                   |                    |
| 1800K   | 90             | 18.2                       | 19.6                          | 111.3                                | 65      | L128-1890HA35000H1               |                   |                    |
| 2200K   | 90             | 23.4                       | 25.3                          | 143.6                                | 65      | L128-2290HA35000H1               |                   |                    |
| 2700K   | 90             | 27.3                       | 28.9                          | 164.1                                | 65      | L128-2790HA35000H1               |                   |                    |
| 3000K   | 90             | 28.9                       | 30.4                          | 172.6                                | 65      | L128-3090HA35000H1               |                   |                    |
| 3500K   | 90             | 29.8                       | 31.3                          | 177.7                                | 65      | L128-3590HA35000H1               |                   |                    |
| 4000K   | 90             | 30.4                       | 31.9                          | 181.1                                | 65      | L128-4090HA35000H1               |                   |                    |
| 5000K   | 90             | 30.4                       | 31.9                          | 181.1                                | 65      | L128-5090HA35000H1               |                   |                    |
| 5700K   | 90             | 30.4                       | 31.9                          | 181.1                                | 65      | L128-5790HA35000H1               |                   |                    |
| 6500K   | 90             | 30.2                       | 31.8                          | 180.5                                | 65      | L128-6590HA35000H1               |                   |                    |

Table 1 continued on next page.

1. Correlated color temperature is cold-targeted at T<sub>j</sub>=25°C for 3V products (LUXEON 2835 HE, LUXEON 2835N 3V, LUXEON 2835E 3V, LUXEON 2835C 3V, and LUXEON 2835C 3V TVS). Correlated color temperature is hot-targeted at T<sub>j</sub>=85°C for 6V and 9V products (LUXEON 2835E 6V, LUXEON 2835E 9V, and LUXEON 2835C 6V).
2. Luminous flux and CRI specs are based upon mounted package on highly reflective surface at T<sub>j</sub>=25°C. Typical CRI is approximately 2 points higher than the minimum CRI specified, but this is not guaranteed.
3. Lumileds maintains a tolerance of ±2 on CRI and ±7.5% on luminous flux measurements.

Table 1. Product performance of LUXEON 2835 Architectural at specified test conditions, continued.

| VOLTAGE      | PRODUCT          | NOMINAL CCT <sup>[1]</sup> | MINIMUM CRI <sup>[2, 3]</sup> | LUMINOUS FLUX <sup>[2, 3]</sup> (lm) |         | TYPICAL LUMINOUS EFFICACY (lm/W) | TEST CURRENT (mA)  | PART NUMBER        |
|--------------|------------------|----------------------------|-------------------------------|--------------------------------------|---------|----------------------------------|--------------------|--------------------|
|              |                  |                            |                               | MINIMUM                              | TYPICAL |                                  |                    |                    |
| 3V           | LUXEON 2835 HE   | 2700K                      | 90                            | 29.8                                 | 31.7    | 180.0                            | 65                 | L128-2790HA35000K1 |
|              |                  | 3000K                      | 90                            | 31.4                                 | 33.4    | 189.6                            | 65                 | L128-3090HA35000K1 |
|              |                  | 3500K                      | 90                            | 32.4                                 | 34.5    | 195.9                            | 65                 | L128-3590HA35000K1 |
|              |                  | 4000K                      | 90                            | 33.0                                 | 35.0    | 198.7                            | 65                 | L128-4090HA35000K1 |
|              |                  | 5000K                      | 90                            | 33.0                                 | 35.0    | 198.7                            | 65                 | L128-5090HA35000K1 |
|              |                  | 5700K                      | 90                            | 33.0                                 | 35.0    | 198.7                            | 65                 | L128-5790HA35000K1 |
|              | 6500K            | 90                         | 33.0                          | 35.0                                 | 198.7   | 65                               | L128-6590HA35000K1 |                    |
|              | LUXEON 2835C TVS | 2700K                      | 80                            | 48.0                                 | 57.8    | 160.6                            | 120                | L128-2780CA35000T1 |
|              |                  | 3000K                      | 80                            | 50.0                                 | 60.5    | 168.1                            | 120                | L128-3080CA35000T1 |
|              |                  | 3500K                      | 80                            | 52.0                                 | 62.0    | 172.2                            | 120                | L128-3580CA35000T1 |
|              |                  | 4000K                      | 80                            | 54.0                                 | 63.0    | 175.0                            | 120                | L128-4080CA35000T1 |
|              |                  | 5000K                      | 80                            | 54.0                                 | 63.0    | 175.0                            | 120                | L128-5080CA35000T1 |
|              |                  | 5700K                      | 80                            | 54.0                                 | 63.0    | 175.0                            | 120                | L128-5780CA35000T1 |
|              | 6500K            | 80                         | 54.0                          | 62.5                                 | 173.6   | 120                              | L128-6580CA35000T1 |                    |
| 6V           | LUXEON 2835E     | 2700K                      | 80                            | 45.0                                 | 54.0    | 145.2                            | 60                 | L128-2780EB3500001 |
|              |                  | 3000K                      | 80                            | 46.0                                 | 55.0    | 147.8                            | 60                 | L128-3080EB3500001 |
|              |                  | 3500K                      | 80                            | 47.0                                 | 56.0    | 150.5                            | 60                 | L128-3580EB3500001 |
|              |                  | 4000K                      | 80                            | 49.0                                 | 59.0    | 158.6                            | 60                 | L128-4080EB3500001 |
|              |                  | 5000K                      | 80                            | 49.0                                 | 59.0    | 158.6                            | 60                 | L128-5080EB3500001 |
|              |                  | 5700K                      | 80                            | 49.0                                 | 59.0    | 158.6                            | 60                 | L128-5780EB3500001 |
|              | 6500K            | 80                         | 49.0                          | 59.0                                 | 158.6   | 60                               | L128-6580EB3500001 |                    |
|              | LUXEON 2835C     | 2700K                      | 80                            | 93.0                                 | 115.0   | 159.7                            | 120                | L128-2780CB3500001 |
|              |                  | 3000K                      | 80                            | 96.0                                 | 118.0   | 163.9                            | 120                | L128-3080CB3500001 |
|              |                  | 3500K                      | 80                            | 99.0                                 | 122.0   | 169.4                            | 120                | L128-3580CB3500001 |
|              |                  | 4000K                      | 80                            | 103.0                                | 125.0   | 173.6                            | 120                | L128-4080CB3500001 |
|              |                  | 5000K                      | 80                            | 103.0                                | 125.0   | 173.6                            | 120                | L128-5080CB3500001 |
|              |                  | 5700K                      | 80                            | 103.0                                | 125.0   | 173.6                            | 120                | L128-5780CB3500001 |
|              |                  | 6500K                      | 80                            | 103.0                                | 124.0   | 172.2                            | 120                | L128-6580CB3500001 |
| 2700K        |                  | 90                         | 78.0                          | 96.0                                 | 133.3   | 120                              | L128-2790CB3500001 |                    |
| LUXEON 2835E | 3000K            | 90                         | 81.0                          | 99.0                                 | 137.5   | 120                              | L128-3090CB3500001 |                    |
|              | 3500K            | 90                         | 83.0                          | 102.0                                | 141.7   | 120                              | L128-3590CB3500001 |                    |
|              | 4000K            | 90                         | 87.0                          | 106.0                                | 147.2   | 120                              | L128-4090CB3500001 |                    |
|              | 5000K            | 90                         | 87.0                          | 106.0                                | 147.2   | 120                              | L128-5090CB3500001 |                    |
|              | 5700K            | 90                         | 87.0                          | 106.0                                | 147.2   | 120                              | L128-5790CB3500001 |                    |
|              | 6500K            | 90                         | 87.0                          | 106.0                                | 147.2   | 120                              | L128-6590CB3500001 |                    |
|              | 6500K            | 70                         | 78.0                          | 93.0                                 | 174.2   | 60                               | L128-6570EC3500001 |                    |
|              | 2200K            | 80                         | 59.0                          | 70.0                                 | 131.1   | 60                               | L128-2280EC3500001 |                    |
| 9V           | LUXEON 2835E     | 2700K                      | 80                            | 67.0                                 | 81.0    | 151.7                            | 60                 | L128-2780EC3500001 |
|              |                  | 3000K                      | 80                            | 70.0                                 | 85.0    | 159.2                            | 60                 | L128-3080EC3500001 |
|              |                  | 3500K                      | 80                            | 72.0                                 | 88.0    | 164.8                            | 60                 | L128-3580EC3500001 |
|              |                  | 4000K                      | 80                            | 74.0                                 | 90.0    | 168.5                            | 60                 | L128-4080EC3500001 |
|              |                  | 5000K                      | 80                            | 74.0                                 | 90.0    | 168.5                            | 60                 | L128-5080EC3500001 |
|              |                  | 5700K                      | 80                            | 74.0                                 | 90.0    | 168.5                            | 60                 | L128-5780EC3500001 |
|              |                  | 6500K                      | 80                            | 74.0                                 | 89.0    | 166.7                            | 60                 | L128-6580EC3500001 |
|              |                  | 2200K                      | 90                            | 50.0                                 | 60.0    | 112.4                            | 60                 | L128-2290EC3500001 |
|              |                  | 2700K                      | 90                            | 54.0                                 | 68.0    | 127.3                            | 60                 | L128-2790EC3500001 |
|              |                  | 3000K                      | 90                            | 57.0                                 | 71.0    | 133.0                            | 60                 | L128-3090EC3500001 |
|              |                  | 3500K                      | 90                            | 60.0                                 | 74.0    | 138.6                            | 60                 | L128-3590EC3500001 |
|              |                  | 4000K                      | 90                            | 62.0                                 | 76.0    | 142.3                            | 60                 | L128-4090EC3500001 |
|              |                  | 5000K                      | 90                            | 62.0                                 | 76.0    | 142.3                            | 60                 | L128-5090EC3500001 |

Table 1 continued on next page.

- Correlated color temperature is cold-targeted at T<sub>c</sub>=25°C for 3V products (LUXEON 2835 HE, LUXEON 2835N 3V, LUXEON 2835E 3V, LUXEON 2835C 3V, and LUXEON 2835C 3V TVS). Correlated color temperature is hot-targeted at T<sub>c</sub>=85°C for 6V and 9V products (LUXEON 2835E 6V, LUXEON 2835E 9V, and LUXEON 2835C 6V).
- Luminous flux and CRI specs are based upon mounted package on highly reflective surface at T<sub>c</sub>=25°C. Typical CRI is approximately 2 points higher than the minimum CRI specified, but this is not guaranteed.
- Lumileds maintains a tolerance of ±2 on CRI and ±7.5% on luminous flux measurements.

Table 1. Product performance of LUXEON 2835 Architectural at specified test conditions, continued.

| VOLTAGE | PRODUCT      | NOMINAL CCT <sup>[1]</sup> | MINIMUM CRI <sup>[2, 3]</sup> | LUMINOUS FLUX <sup>[2, 3]</sup> (lm) |         | TYPICAL LUMINOUS EFFICACY (lm/W) | TEST CURRENT (mA) | PART NUMBER        |
|---------|--------------|----------------------------|-------------------------------|--------------------------------------|---------|----------------------------------|-------------------|--------------------|
|         |              |                            |                               | MINIMUM                              | TYPICAL |                                  |                   |                    |
| 9V      | LUXEON 2835E | 6500K                      | 70                            | 120.0                                | 142.0   | 152.7                            | 100               | L128-6570EC35000B1 |
|         |              | 2200K                      | 80                            | 92.0                                 | 108.0   | 116.1                            | 100               | L128-2280EC35000B1 |
|         |              | 2700K                      | 80                            | 106.0                                | 125.0   | 134.4                            | 100               | L128-2780EC35000B1 |
|         |              | 3000K                      | 80                            | 110.0                                | 129.0   | 138.7                            | 100               | L128-3080EC35000B1 |
|         |              | 3500K                      | 80                            | 113.0                                | 133.5   | 143.5                            | 100               | L128-3580EC35000B1 |
|         |              | 4000K                      | 80                            | 116.0                                | 137.0   | 147.3                            | 100               | L128-4080EC35000B1 |
|         |              | 5000K                      | 80                            | 116.0                                | 137.0   | 147.3                            | 100               | L128-5080EC35000B1 |
|         |              | 5700K                      | 80                            | 116.0                                | 137.0   | 147.3                            | 100               | L128-5780EC35000B1 |
|         |              | 6500K                      | 80                            | 116.0                                | 137.0   | 147.3                            | 100               | L128-6580EC35000B1 |
|         |              | 2200K                      | 90                            | 77.0                                 | 92.0    | 98.9                             | 100               | L128-2290EC35000B1 |
|         |              | 2700K                      | 90                            | 87.0                                 | 104.0   | 111.8                            | 100               | L128-2790EC35000B1 |
|         |              | 3000K                      | 90                            | 91.0                                 | 108.0   | 116.1                            | 100               | L128-3090EC35000B1 |
|         |              | 3500K                      | 90                            | 95.0                                 | 113.0   | 121.5                            | 100               | L128-3590EC35000B1 |
|         |              | 4000K                      | 90                            | 98.0                                 | 116.0   | 124.7                            | 100               | L128-4090EC35000B1 |
|         |              | 5000K                      | 90                            | 98.0                                 | 116.0   | 124.7                            | 100               | L128-5090EC35000B1 |

Notes for Table 1:

- Correlated color temperature is cold-targeted at T<sub>j</sub>=25°C for 3V products (LUXEON 2835 HE, LUXEON 2835N 3V, LUXEON 2835E 3V, LUXEON 2835C 3V, and LUXEON 2835C 3V TVS). Correlated color temperature is hot-targeted at T<sub>j</sub>=85°C for 6V and 9V products (LUXEON 2835E 6V, LUXEON 2835E 9V, and LUXEON 2835C 6V).
- Luminous flux and CRI specs are based upon mounted package on highly reflective surface at T<sub>j</sub>=25°C. Typical CRI is approximately 2 points higher than the minimum CRI specified, but this is not guaranteed.
- Lumileds maintains a tolerance of ±2 on CRI and ±7.5% on luminous flux measurements.

## Optical Characteristics

Table 2. Optical characteristics for LUXEON 2835 Architectural at specified test current, T<sub>j</sub>=25°C.

| PART NUMBER       | TYPICAL TOTAL INCLUDED ANGLE <sup>[1]</sup> | TYPICAL VIEWING ANGLE <sup>[2]</sup> |
|-------------------|---|--------------------------------------|
| L128-xxxxx35000x1 | 160°  | 120°                                 |

Notes for Table 2:

- Total angle at which 90% of total luminous flux is captured.
- Viewing angle is the off axis angle from the LED centerline where the luminous intensity is ½ of the peak value.

## Electrical and Thermal Characteristics

Table 3. Electrical and thermal characteristics for LUXEON 2835 Architectural at specified test current, T<sub>j</sub>=25°C.

| PART NUMBER        | FORWARD VOLTAGE <sup>[1]</sup> (V <sub>f</sub> ) |         |         | TYPICAL TEMPERATURE COEFFICIENT OF FORWARD VOLTAGE <sup>[2]</sup> (mV/°C) | TYPICAL THERMAL RESISTANCE—JUNCTION TO SOLDER PAD (°C/W) |
|--------------------|--|---------|---------|---|--|
|                    | MINIMUM  | TYPICAL | MAXIMUM |   |  |
| L128-xxxxEC3500001 | 8.4  | 8.9     | 9.9     | -3.0 to -6.0  | 15   |
| L128-xxxxEC35000B1 | 8.7  | 9.3     | 9.9     | -3.0 to -6.0  | 15   |
| L128-xxxxEB3500001 | 5.6  | 6.1     | 6.6     | -2.0 to -4.0  | 20   |
| L128-xxxxEA3500001 | 2.7  | 2.9     | 3.1     | -1.0 to -2.0  | 39   |
| L128-xxxxCB3500001 | 5.8  | 6.0     | 6.6     | -2.0 to -4.0  | 11   |
| L128-xxxxCA35000x1 | 2.9  | 3.0     | 3.2     | -1.0 to -2.0  | 21   |
| L128-xxxxNA35000x1 | 2.68   | 2.75    | 2.88    | -1.0 to -2.0  | 14   |
| L128-xxxxHA35000x1 | 2.66   | 2.71    | 2.76    | -1.0 to -2.0  | 10   |

Notes for Table 3:

- Lumileds maintains a tolerance of ±0.1V on forward voltage measurements.
- Measured between 25°C and 85°C.

# Absolute Maximum Ratings

Table 4. Absolute maximum ratings for LUXEON 2835 Architectural.

| PARAMETER  | MAXIMUM PERFORMANCE  |
|--|--|
| DC Forward Current <sup>[1,2]</sup>                  | 150mA for L128-xxxxEC35000x1<br>150mA for L128-xxxxEB3500001<br>150mA for L128-xxxxEA3500001<br>240mA for L128-xxxxCx35000x1<br>300mA for L128-xxxxNA35000x1<br>480mA for L128-xxxxHA35000x1 |
| Peak Pulsed Forward Current <sup>[1,3]</sup>         | 200mA for L128-xxxxEx35000x1<br>300mA for L128-xxxxCx35000x1<br>450mA for L128-xxxxNA35000x1<br>600mA for L128-xxxxHA35000x1   |
| LED Junction Temperature <sup>[1]</sup> (DC & Pulse) | 125°C for L128-xxxxEC35000x1<br>125°C for L128-xxxxEB3500001<br>115°C for L128-xxxxEA3500001<br>125°C for L128-xxxxCx35000x1<br>125°C for L128-xxxxNA35000x1<br>125°C for L128-xxxxHA35000x1 |
| ESD Sensitivity (ANSI/ESDA/JEDEC JS-001-2012)        | Class 3B for LUXEON 2835C 3V TVS with ESD protection<br>Class 2 for all other LUXEON 2835 parts  |
| Operating Case Temperature <sup>[1]</sup>            | -40°C to 105°C   |
| LED Storage Temperature                              | -40°C to 105°C   |
| Soldering Temperature                                | JEDEC 020c 260°C   |
| Allowable Reflow Cycles                              | 3  |
| Reverse Voltage <sup>[4,5]</sup> ( $V_{reverse}$ )   | 5  |

**Notes for Table 4:**

- Proper current derating must be observed to maintain the junction temperature below the maximum allowable junction temperature.
- Residual periodic variations due to power conversion from alternating current (AC) to direct current (DC), also called "ripple," are acceptable if the following conditions are met:
  - The frequency of the ripple current is 100Hz or higher
  - The average current for each cycle does not exceed the maximum allowable DC forward current
  - The maximum amplitude of the ripple does not exceed the maximum peak pulsed forward current
- At ≤50% duty cycle with pulse width of 5ms.
- Transient reverse voltages and surge currents due to electrical switching or supply interruptions are acceptable if these events do not last for more than 10ms, the amplitude of the reverse voltage does not exceed 5V and the reverse current is less than 220uA.
- Max 5V reverse for up to 10s is an acceptable beginning of life, one time test condition.



# Characteristics Curves

## Spectral Power Distribution Characteristics

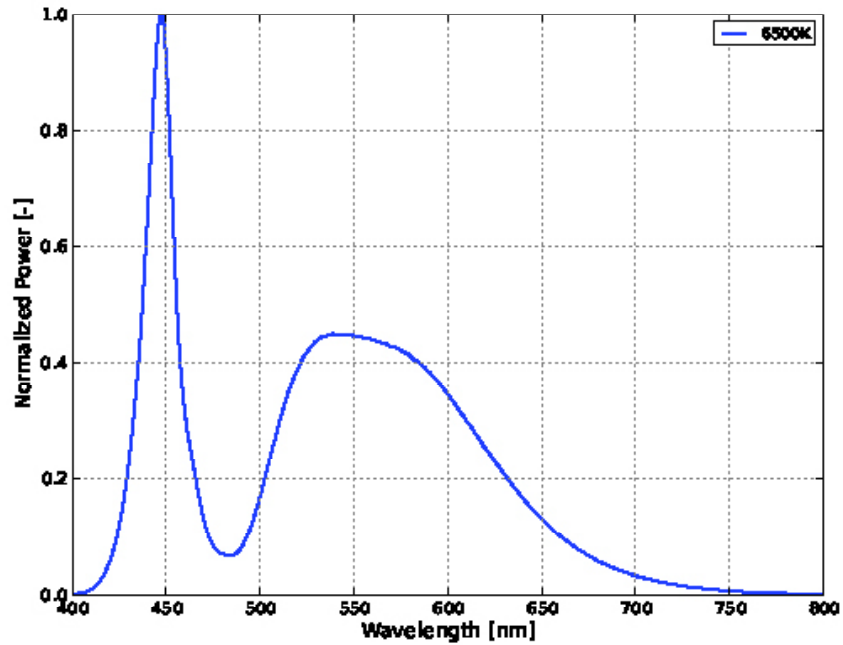

Figure 1a. Typical normalized power vs. wavelength for 70CRI LUXEON 2835E and LUXEON 2835C at specified test current,  $T_j=25^{\circ}\text{C}$ .

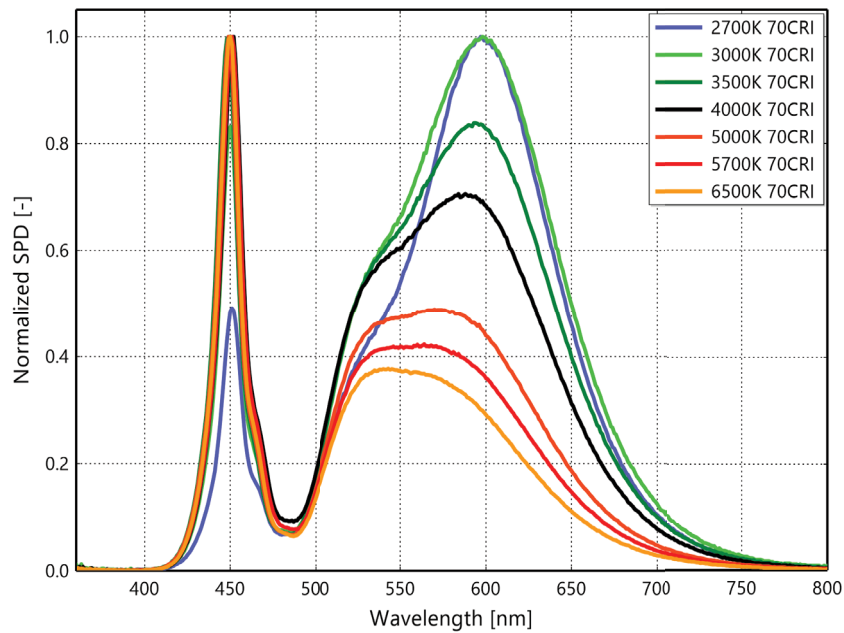

Figure 1b. Typical normalized SPD vs. wavelength for 70CRI LUXEON 2835 HE at specified test current,  $T_j=25^{\circ}\text{C}$ .

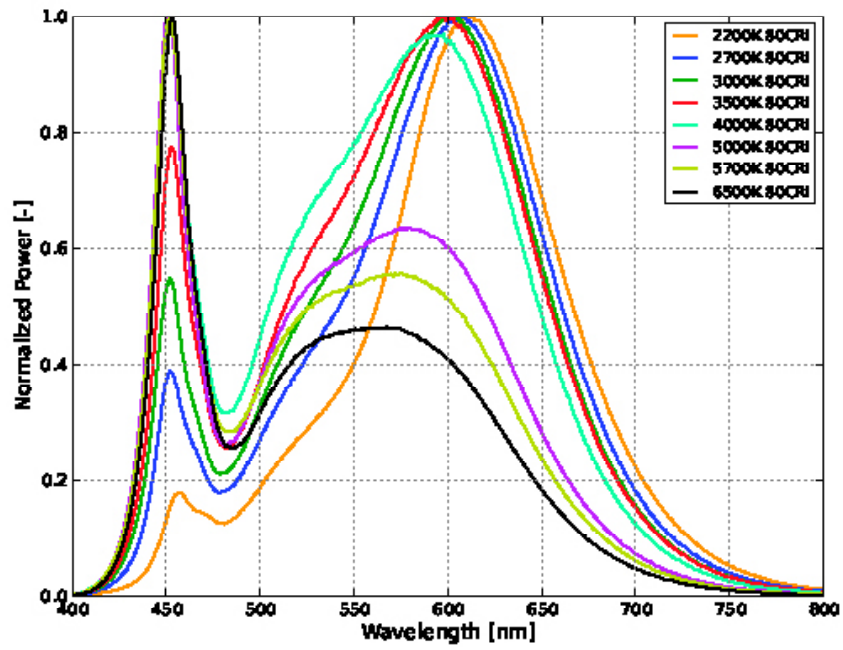

Figure 1c. Typical normalized power vs. wavelength for 80CRI LUXEON 2835E and LUXEON 2835C at specified test current,  $T_j=25^{\circ}\text{C}$ .

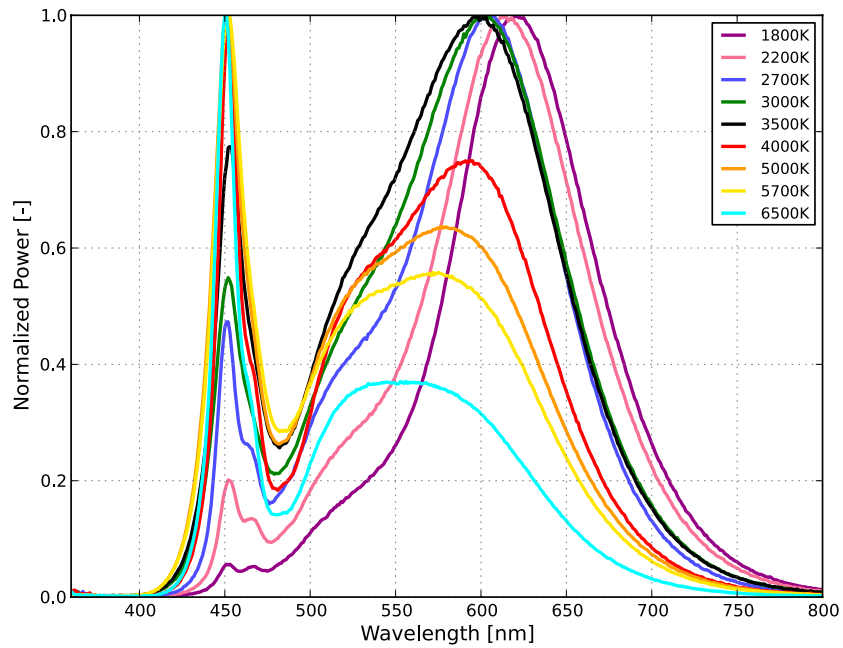

Figure 1d. Typical normalized power vs. wavelength for 80CRI LUXEON 2835 HE and LUXEON 2835N 3V at specified test current,  $T_j=25^{\circ}\text{C}$ .

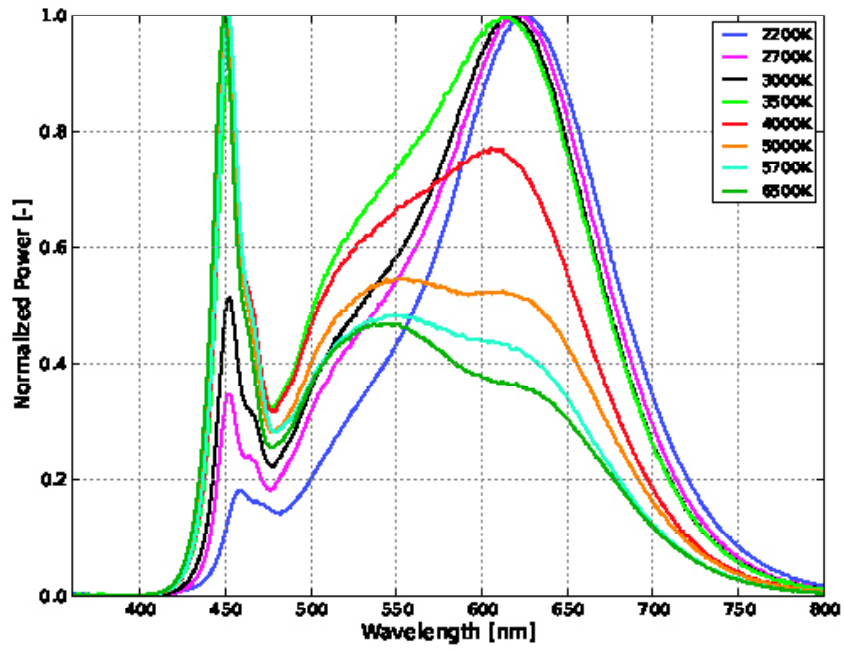

Figure 1e. Typical normalized power vs. wavelength for 90CRI LUXEON 2835E and LUXEON 2835C at specified test current,  $T_j=25^\circ\text{C}$ .

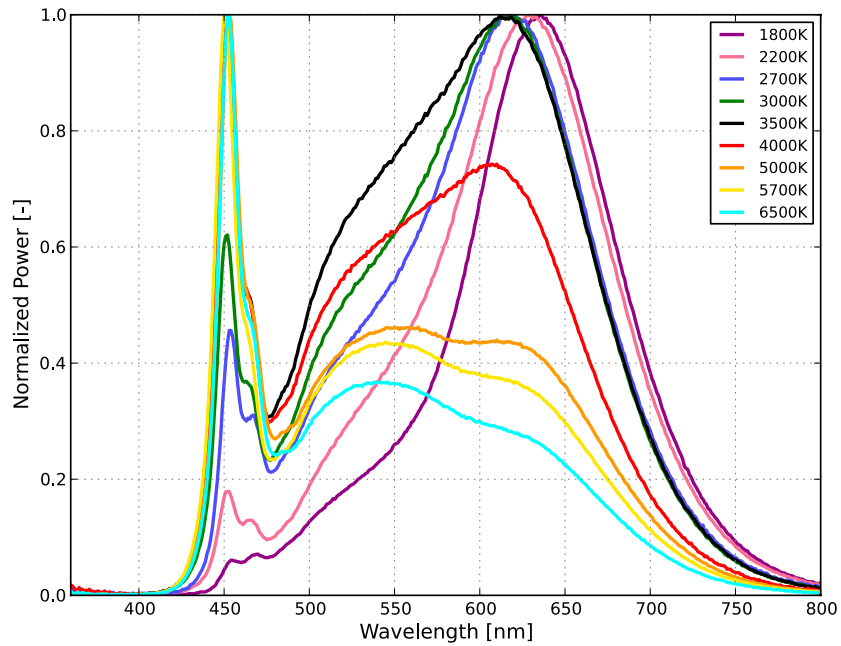

Figure 1f. Typical normalized power vs. wavelength for 90CRI LUXEON 2835 HE and LUXEON 2835N 3V at specified test current,  $T_j=25^\circ\text{C}$ .

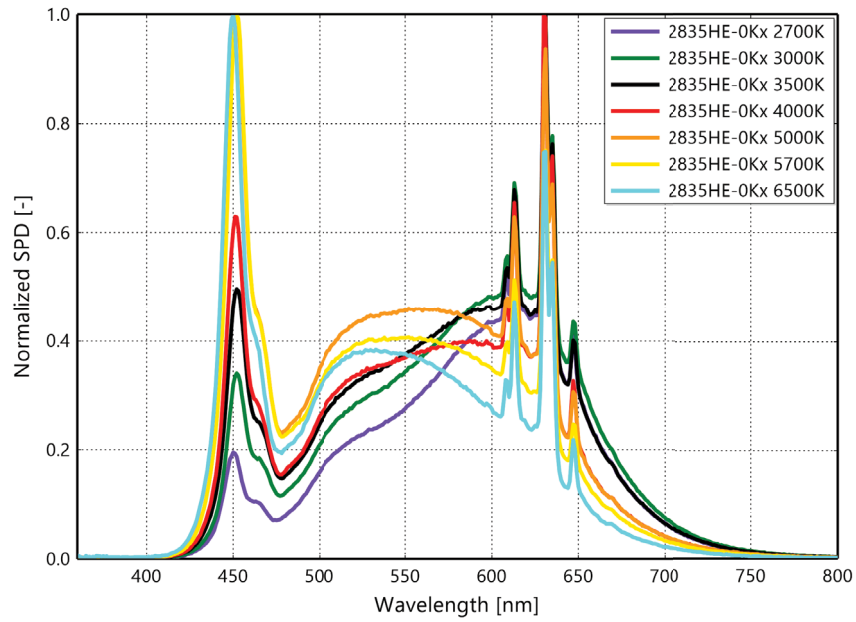

Figure 1g. Typical normalized SPD vs. wavelength for 90CRI LUXEON 2835 HE ended with 0Kx and associated parts at specified test current,  $T_j=25^\circ\text{C}$ .

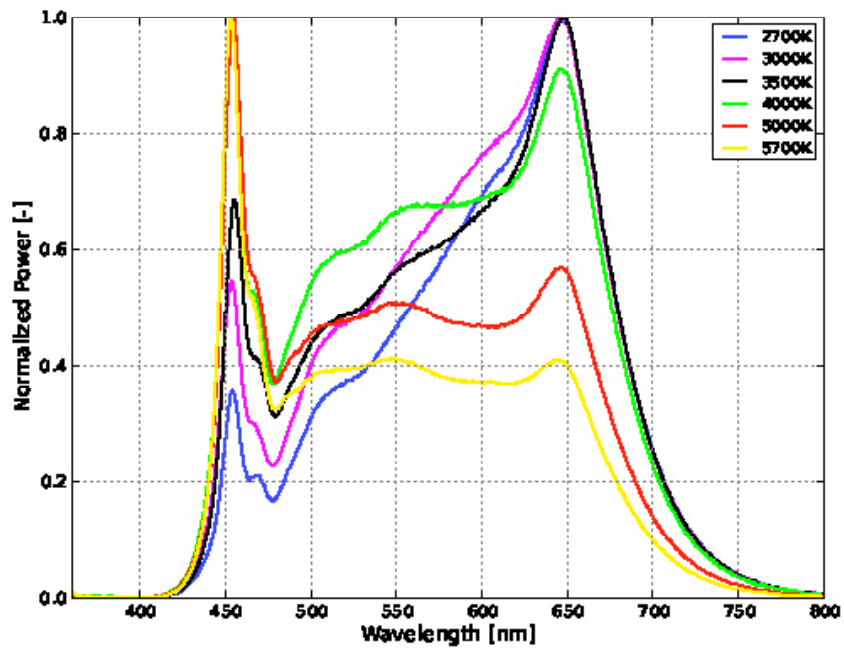

Figure 1h. Typical normalized power vs. wavelength for 95CRI LUXEON 2835 HE at specified test current,  $T_j=25^\circ\text{C}$ .

# Light Output Characteristics

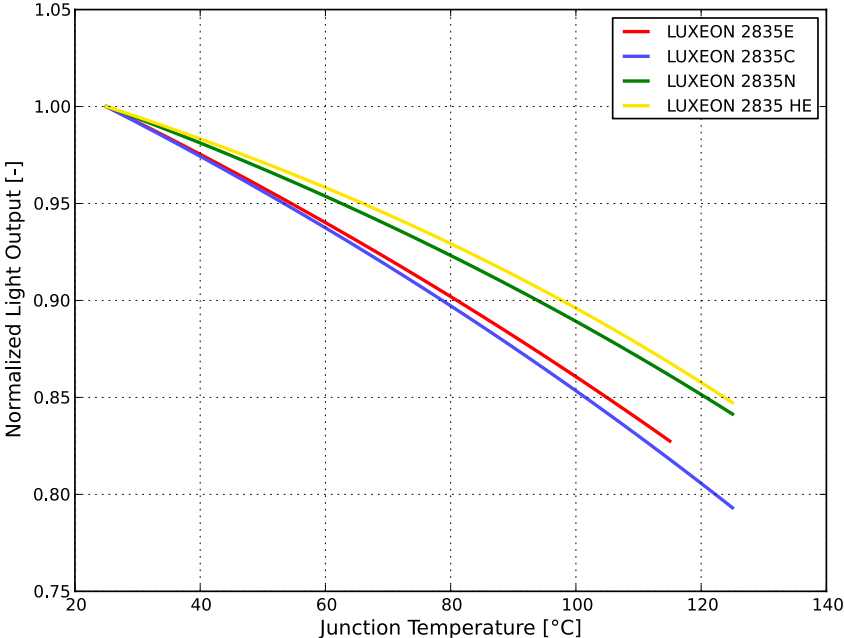
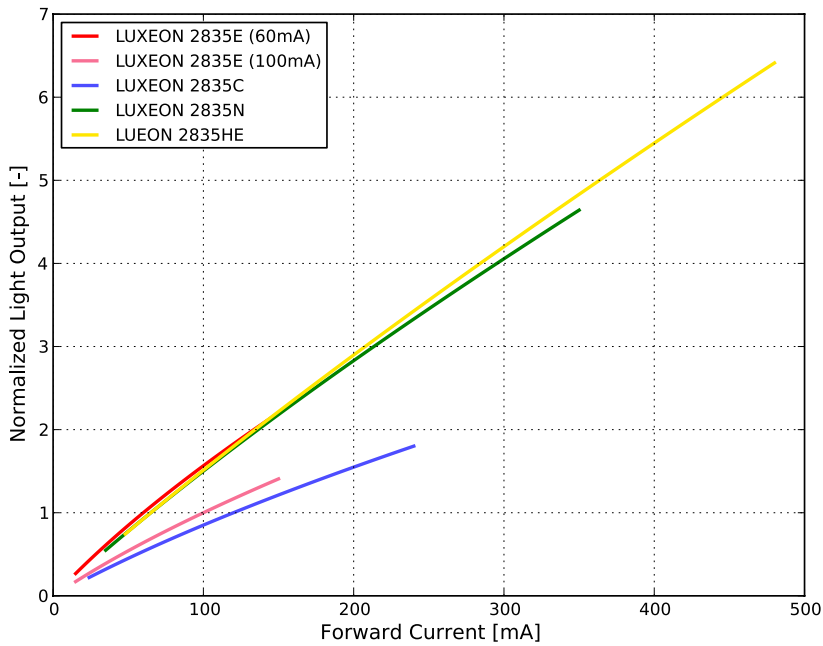

Figure 2. Typical normalized light output vs. junction temperature for LUXEON 2835 Architectural at specified test current.



LUXEON 2835E estimated typical ratio compared to flux at rated condition 60mA,  $T_j=25^{\circ}\text{C}$ .

| PRODUCT  | 30mA | 50mA | 80mA | 100mA | 120mA |
|----------|------|------|------|-------|-------|
| 2835E 3V | 53%  | 85%  | 129% | 158%  | 185%  |
| 2835E 6V | 53%  | 85%  | 129% | 156%  | 182%  |
| 2835E 9V | 53%  | 85%  | 129% | 157%  | 183%  |

LUXEON 2835C estimated typical ratio compared to flux at rated condition 120mA,  $T_j=25^{\circ}\text{C}$ .

| PRODUCT  | 50mA | 65mA | 100mA | 150mA | 200mA |
|----------|------|------|-------|-------|-------|
| 2835C 3V | 44%  | 56%  | 85%   | 123%  | 159%  |
| 2835C 6V | 44%  | 56%  | 84%   | 123%  | 158%  |

LUXEON 2835 HE estimated typical ratio compared to flux at rated condition 65mA,  $T_j=25^{\circ}\text{C}$ .

| PRODUCT | 30mA | 65mA | 100mA | 150mA | 200mA |
|---------|------|------|-------|-------|-------|
| 2835 HE | 47%  | 100% | 152%  | 223%  | 292%  |

LUXEON 2835N 3V estimated typical ratio compared to flux at rated condition 65mA,  $T_j=25^{\circ}\text{C}$ .

| PRODUCT  | 30mA | 65mA | 100mA | 150mA | 200mA |
|----------|------|------|-------|-------|-------|
| 2835N 3V | 46%  | 100% | 150%  | 220%  | 285%  |

Figure 3. Typical normalized light output vs. forward current for LUXEON 2835 Architectural at  $T_j=25^{\circ}\text{C}$ .

# Forward Current Characteristics

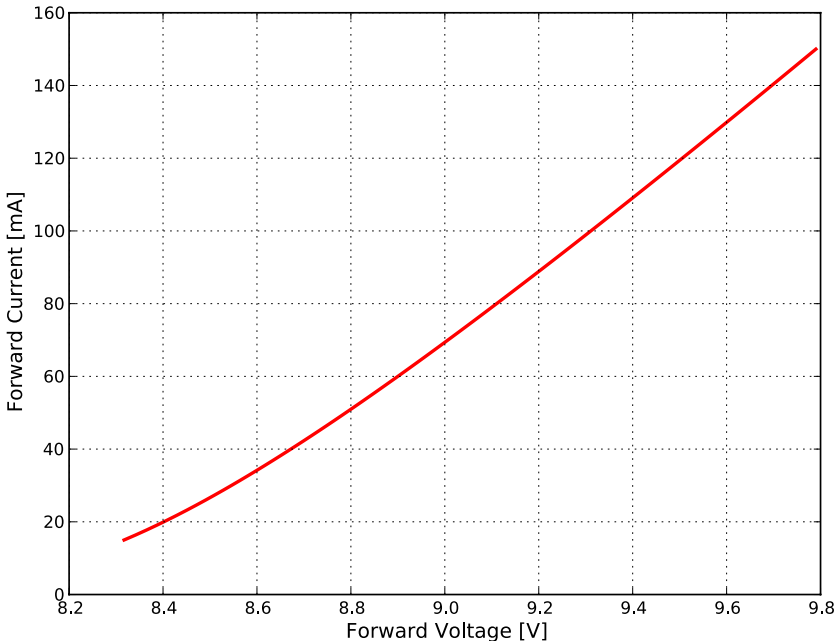

Figure 4a. Typical forward current vs. forward voltage for LUXEON 2835E 9V at  $T_j=25^\circ\text{C}$ .

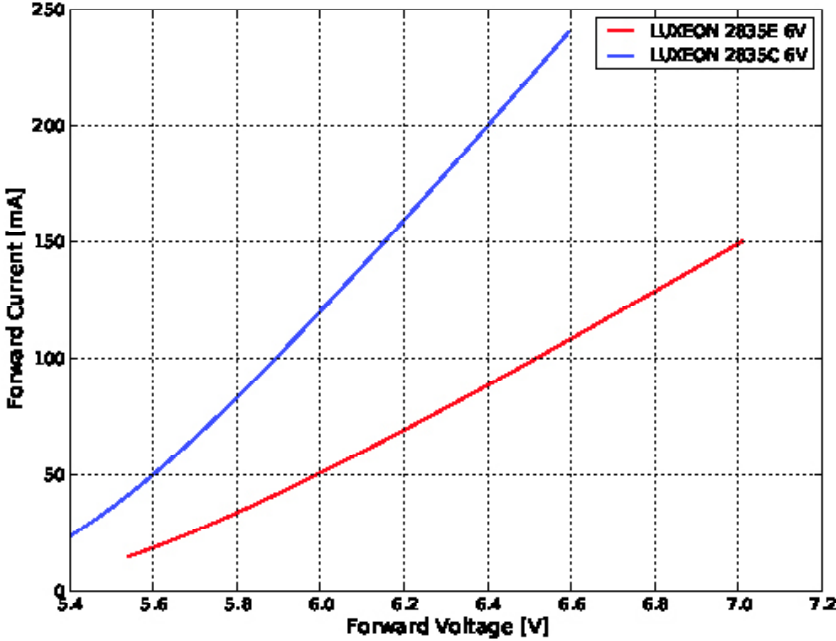

Figure 4b. Typical forward current vs. forward voltage for LUXEON 2835E 6V and LUXEON 2835C 6V at  $T_j=25^\circ\text{C}$ .

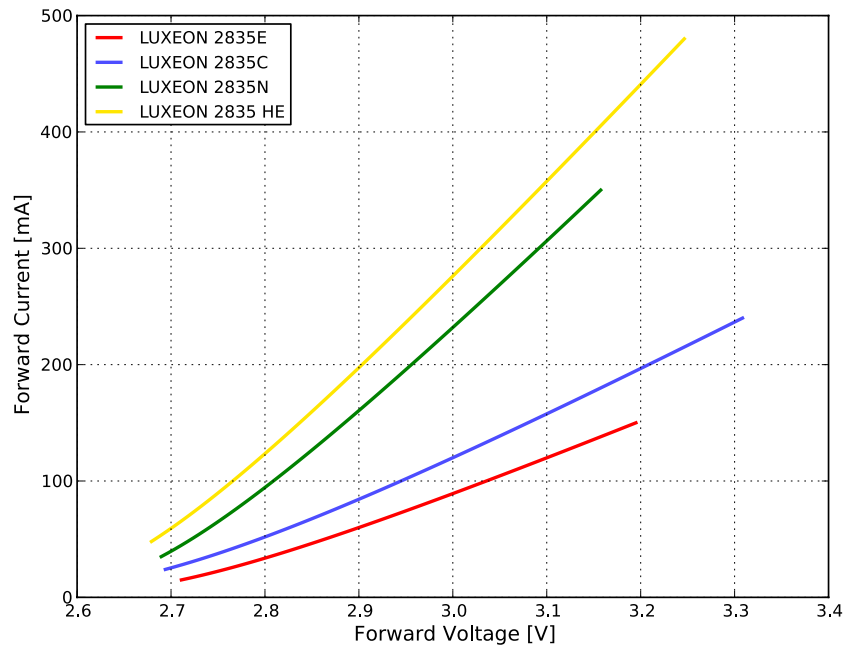

Figure 4c. Typical forward current vs. forward voltage for LUXEON 2835C Line 3V at  $T_j=25^\circ\text{C}$ .



# Radiation Pattern Characteristics

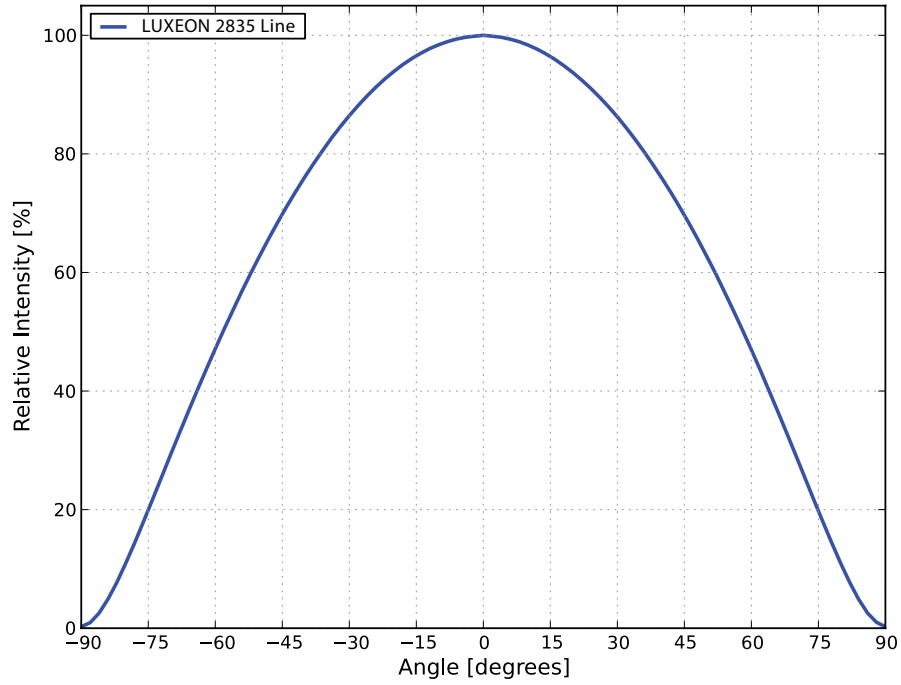

Figure 5. Typical radiation pattern for LUXEON 2835 Architectural at test current,  $T_j=25^{\circ}\text{C}$ .

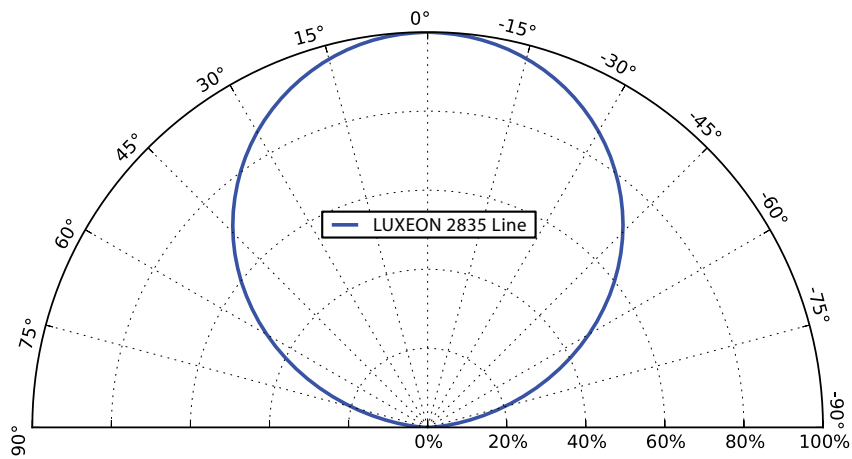

Figure 6. Typical polar radiation pattern for LUXEON 2835 Architectural at test current,  $T_j=25^{\circ}\text{C}$ .

# Product Bin and Labeling Definitions

## Decoding Product Bin Labeling

In the manufacturing of semiconductor products, there are variations in performance around the average values given in the technical datasheet. For this reason, Lumileds bins LED components for luminous flux or radiometric power, color point, peak or dominant wavelength and forward voltage.

LUXEON 2835 Architectural LEDs are labeled using a 4- or 5-digit alphanumeric CAT code following the format below:

**A or Ax B C D**

Where:

**A or Ax** – designates luminous flux bin (example: T=56 to 60 lm, D2=29 to 31 lm)

**B C** – designates correlated color bin (example: 5D, 5E, 5F, 5G, 5H, 5J, 5K, 5L, 5M for 4000K parts)

**D** – designates forward voltage bin (example: W=3.0 to 3.1V, X=3.1 to 3.2V)

Therefore, a LUXEON 2835C 3V LED with a lumen range of 56 to 60 lm, color bin of 5D and a forward voltage range of 3.0 to 3.1V has the following CAT code:

**T 5 D W**

## Luminous Flux Bins

Table 5 lists the standard luminous flux bins for LUXEON 2835 Architectural emitters. Although several bins are outlined, product availability in a particular bin varies by production run and by product performance. Not all bins are available in all CCTs.

**Table 5. Luminous flux bin definitions for LUXEON 2835 Architectural,  $T_j=25^\circ\text{C}$ .**

| PRODUCT                                | BIN | LUMINOUS FLUX <sup>(1)</sup> (lm) |         |
|--|-----|-----------------------------------|---------|
|  |     | MINIMUM                           | MAXIMUM |
| LUXEON 2835E 9V<br>LUXEON 2835C 6V     | Z   | 50                                | 55      |
|  | A   | 55                                | 60      |
|  | B   | 60                                | 65      |
|  | C   | 65                                | 70      |
|  | D   | 70                                | 75      |
|  | E   | 75                                | 80      |
|  | F   | 80                                | 85      |
|  | G   | 85                                | 90      |
|  | H   | 90                                | 95      |
|  | J   | 95                                | 100     |
|  | K   | 100                               | 105     |
|  | L   | 105                               | 110     |
|  | M   | 110                               | 115     |
|  | N   | 115                               | 120     |
|  | P   | 120                               | 125     |
|  | Q   | 125                               | 130     |
|  | R   | 130                               | 135     |
|  | S   | 135                               | 140     |
|  | T   | 140                               | 145     |
|  | U   | 145                               | 150     |
| LUXEON 2835E 3V                        | B1  | 19                                | 21      |
|  | B2  | 21                                | 23      |
|  | C1  | 23                                | 25      |
|  | C2  | 25                                | 27      |
|  | D1  | 27                                | 29      |
|  | D2  | 29                                | 31      |
|  | E1  | 31                                | 33      |
| LUXEON 2835C 3V<br>LUXEON 2835C 3V TVS | P   | 40                                | 44      |
|  | Q   | 44                                | 48      |
|  | R   | 48                                | 52      |
|  | S   | 52                                | 56      |
|  | T   | 56                                | 60      |
|  | U   | 60                                | 63      |
|  | V   | 63                                | 66      |
|  | W   | 66                                | 69      |
|  | X   | 69                                | 72      |
|  | Y   | 72                                | 75      |

Table 5 continued on next page:

1. Lumileds maintains a tolerance of  $\pm 7.5\%$  on luminous flux measurements.

Table 5. Luminous flux bin definitions for LUXEON 2835 Architectural, T<sub>j</sub>=25°C (continued).

| PRODUCT                              | BIN  | LUMINOUS FLUX <sup>(1)</sup> (lm) |         |
|--------------------------------------|------|-----------------------------------|---------|
|                                      |      | MINIMUM                           | MAXIMUM |
| LUXEON 2835E 6V                      | P    | 40                                | 44      |
|                                      | Q    | 44                                | 48      |
|                                      | R    | 48                                | 52      |
|                                      | S    | 52                                | 56      |
|                                      | T    | 56                                | 60      |
|                                      | U    | 60                                | 65      |
|                                      | V    | 65                                | 70      |
|                                      | W    | 70                                | 75      |
| LUXEON 2835 HE 3V<br>LUXEON 2835N 3V | T    | 17.5                              | 19.0    |
|                                      | U    | 19.0                              | 20.5    |
|                                      | V    | 20.5                              | 22.0    |
|                                      | W    | 22.0                              | 23.5    |
|                                      | X    | 23.5                              | 25.0    |
|                                      | Y    | 25.0                              | 26.5    |
|                                      | Z    | 26.5                              | 28.0    |
|                                      | A    | 28.0                              | 29.5    |
|                                      | B    | 29.5                              | 31.0    |
|                                      | C    | 31.0                              | 32.5    |
|                                      | D    | 32.5                              | 34.0    |
|                                      | E    | 34.0                              | 35.5    |
|                                      | F    | 35.5                              | 37.0    |
|                                      | G    | 37.0                              | 38.5    |
|                                      | H    | 38.5                              | 40.0    |
| J                                    | 40.0 | 41.5                              |         |
| K                                    | 41.5 | 43.0                              |         |

Notes for Table 5:

1. Lumileds maintains a tolerance of ±7.5% on luminous flux measurements.

# Color Bin Definition

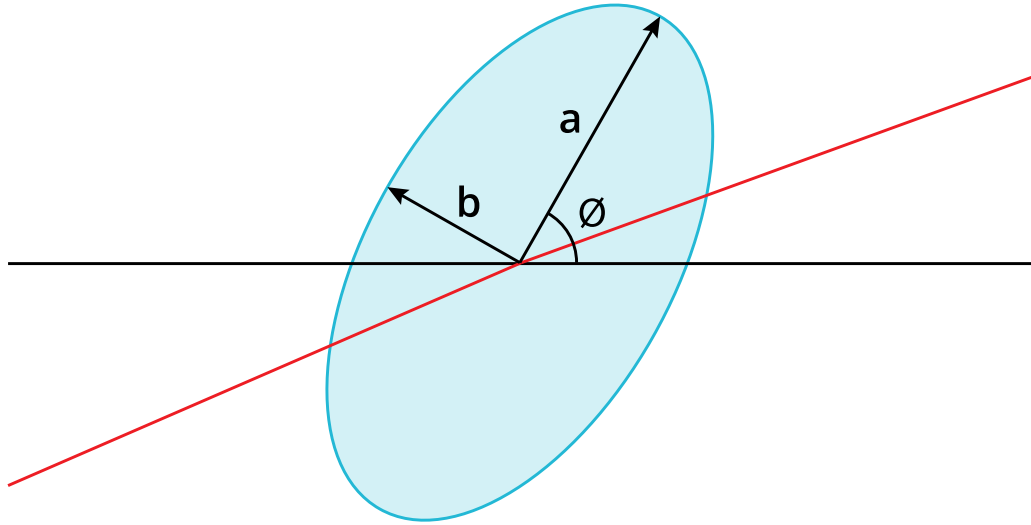

Figure 7. 3- and 5-step MacAdam ellipse illustration for Tables 6a–6h.

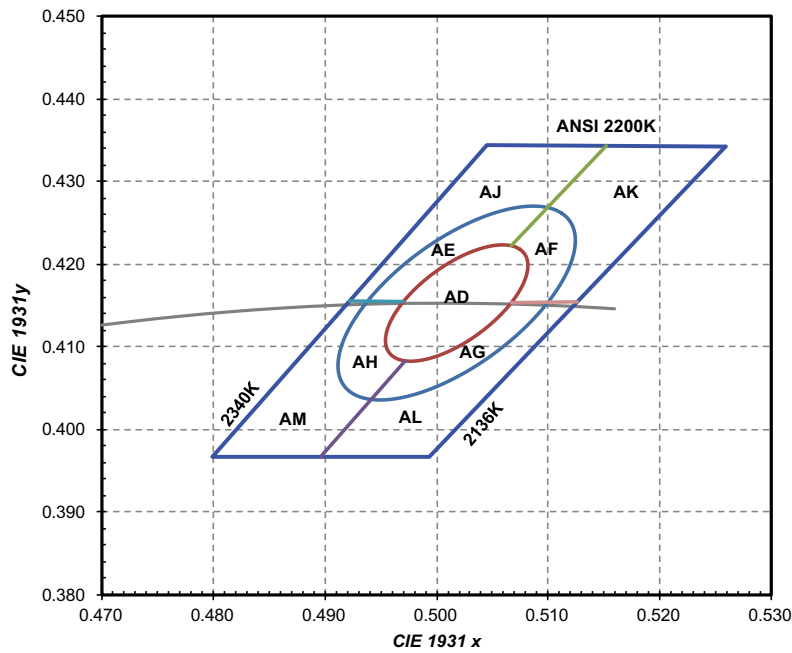

Figure 8a. 1/9<sup>th</sup> color bin structure for LUXEON 2835E and LUXEON 2835C 2200K at specified test current and binning temperatures of  $T_j=25^\circ\text{C}$  and  $T_j=85^\circ\text{C}$ .

Table 6a. 3- and 5-step MacAdam ellipse color bin definitions for LUXEON 2835E and LUXEON 2835C 2200K, at specified test and binning conditions.

| NOMINAL CCT | COLOR SPACE                   | CENTER POINT <sup>[1]</sup><br>(cx, cy) | MAJOR AXIS,<br>a | MINOR AXIS,<br>b | ELLIPSE ROTATION<br>ANGLE, Ø |
|-------------|-------------------------------|---|------------------|------------------|------------------------------|
| 2200K       | Single 3-step MacAdam ellipse | (0.5018, 0.4153)                        | 0.00863          | 0.00398          | 49.27°                       |
| 2200K       | Single 5-step MacAdam ellipse | (0.5018, 0.4153)                        | 0.01438          | 0.00663          | 49.27°                       |

Notes for Table 6a:

1. Lumileds maintains a tolerance of  $\pm 0.007$  on x and y color coordinates in the CIE 1931 color space.

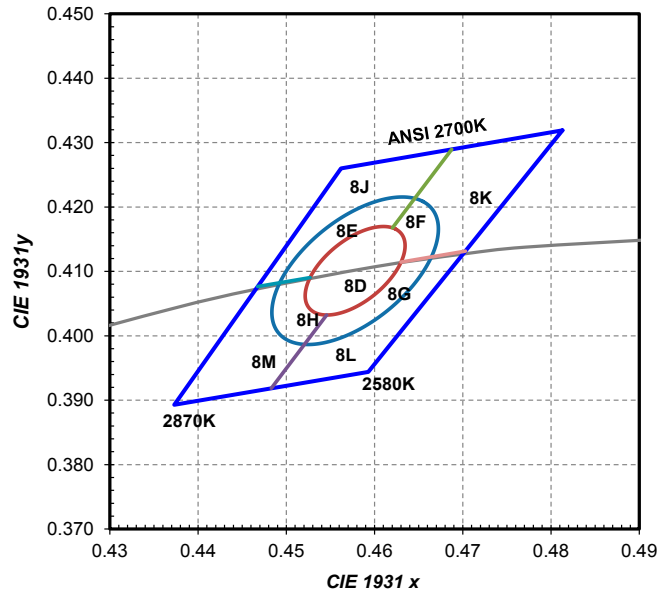

Figure 8b. 1/9<sup>th</sup> color bin structure for LUXEON 2835E and LUXEON 2835C 2700K at specified test current and binning temperatures of  $T_j=25^{\circ}\text{C}$  and  $T_j=85^{\circ}\text{C}$ .

Table 6b. 3- and 5-step MacAdam ellipse color bin definitions for LUXEON 2835E and LUXEON 2835C 2700K, at specified test and binning conditions.

| NOMINAL CCT | COLOR SPACE                   | CENTER POINT <sup>[1]</sup><br>(cx, cy) | MAJOR AXIS,<br>a | MINOR AXIS,<br>b | ELLIPSE ROTATION<br>ANGLE, $\theta$ |
|-------------|-------------------------------|---|------------------|------------------|-------------------------------------|
| 2700K       | Single 3-step MacAdam ellipse | (0.4578, 0.4101)                        | 0.00810          | 0.00420          | 53.70°                              |
| 2700K       | Single 5-step MacAdam ellipse | (0.4578, 0.4101)                        | 0.01350          | 0.00700          | 53.70°                              |

Notes for Table 6b:

- Lumileds maintains a tolerance of  $\pm 0.007$  on x and y color coordinates in the CIE 1931 color space.

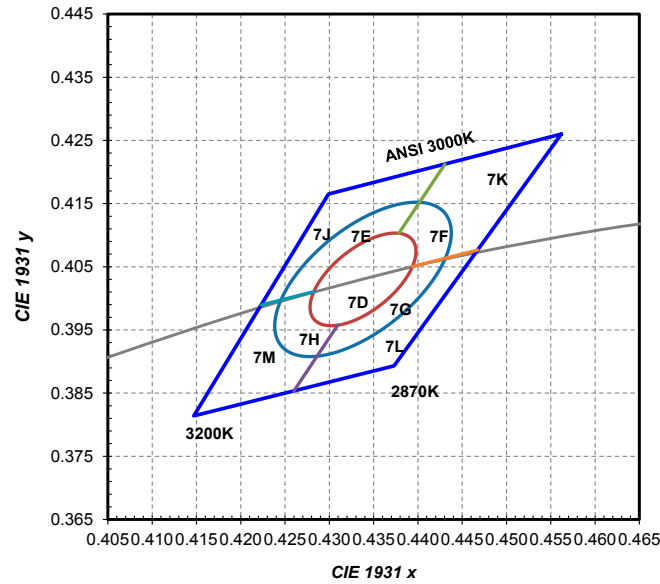

Figure 8c. 1/9<sup>th</sup> color bin structure for LUXEON 2835E and LUXEON 2835C 3000K at specified test current and binning temperatures of  $T_j=25^{\circ}\text{C}$  and  $T_j=85^{\circ}\text{C}$ .

Table 6c. 3- and 5-step MacAdam ellipse color bin definitions for LUXEON 2835E and LUXEON 2835C 3000K, at at specified test and binning conditions.

| NOMINAL CCT | COLOR SPACE                   | CENTER POINT <sup>[1]</sup><br>(cx, cy) | MAJOR AXIS,<br>a | MINOR AXIS,<br>b | ELLIPSE ROTATION<br>ANGLE, $\theta$ |
|-------------|-------------------------------|---|------------------|------------------|-------------------------------------|
| 3000K       | Single 3-step MacAdam ellipse | (0.4338, 0.4030)                        | 0.00834          | 0.00408          | 53.22°                              |
| 3000K       | Single 5-step MacAdam ellipse | (0.4338, 0.4030)                        | 0.01390          | 0.00680          | 53.22°                              |

Notes for Table 6c:

- Lumileds maintains a tolerance of  $\pm 0.007$  on x and y color coordinates in the CIE 1931 color space.

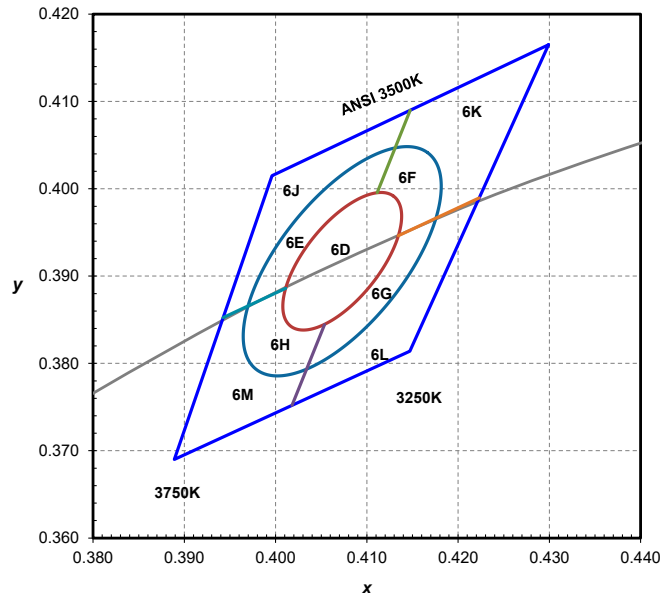

Figure 8d. 1/9<sup>th</sup> color bin structure for LUXEON 2835E and LUXEON 2835C 3500K at specified test current and binning temperatures of  $T_j=25^{\circ}\text{C}$  and  $T_j=85^{\circ}\text{C}$ .

Table 6d. 3- and 5-step MacAdam ellipse color bin definitions for LUXEON 2835E and LUXEON 2835C 3500K, at specified test and binning conditions.

| NOMINAL CCT | COLOR SPACE                   | CENTER POINT <sup>(1)</sup><br>(cx, cy) | MAJOR AXIS,<br>a | MINOR AXIS,<br>b | ELLIPSE ROTATION<br>ANGLE, $\theta$ |
|-------------|-------------------------------|---|------------------|------------------|-------------------------------------|
| 3500K       | Single 3-step MacAdam ellipse | (0.4073, 0.3917)                        | 0.00927          | 0.00414          | 54.00°                              |
| 3500K       | Single 5-step MacAdam ellipse | (0.4073, 0.3917)                        | 0.01545          | 0.00690          | 54.00°                              |

Notes for Table 6d:

1. Lumileds maintains a tolerance of  $\pm 0.007$  on x and y color coordinates in the CIE 1931 color space.

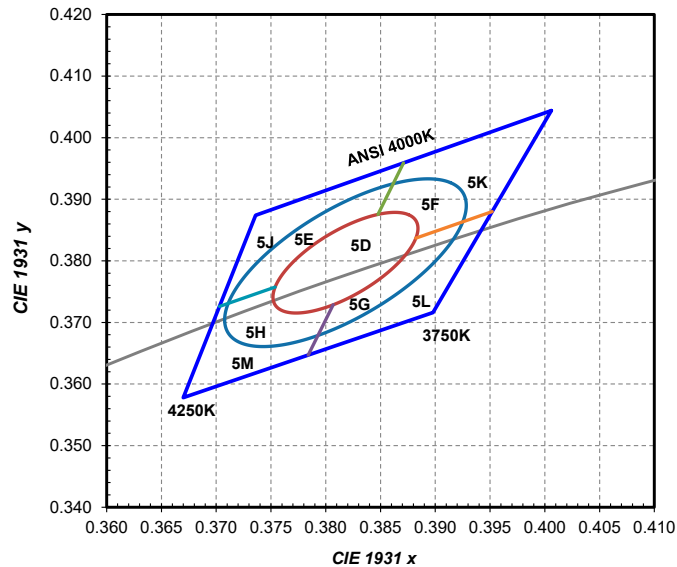

Figure 8e. 1/9<sup>th</sup> color bin structure for LUXEON 2835E and LUXEON 2835C 4000K at specified test current and binning temperatures of  $T_j=25^{\circ}\text{C}$  and  $T_j=85^{\circ}\text{C}$ .

Table 6e. 3- and 5-step MacAdam ellipse color bin definitions for LUXEON 2835E and LUXEON 2835C 4000K, at specified test and binning conditions.

| NOMINAL CCT | COLOR SPACE                   | CENTER POINT <sup>(1)</sup><br>(cx, cy) | MAJOR AXIS,<br>a | MINOR AXIS,<br>b | ELLIPSE ROTATION<br>ANGLE, $\theta$ |
|-------------|-------------------------------|---|------------------|------------------|-------------------------------------|
| 4000K       | Single 3-step MacAdam ellipse | (0.3818, 0.3797)                        | 0.00939          | 0.00402          | 53.72°                              |
| 4000K       | Single 5-step MacAdam ellipse | (0.3818, 0.3797)                        | 0.01565          | 0.00670          | 53.72°                              |

Notes for Table 6e:

1. Lumileds maintains a tolerance of  $\pm 0.007$  on x and y color coordinates in the CIE 1931 color space.

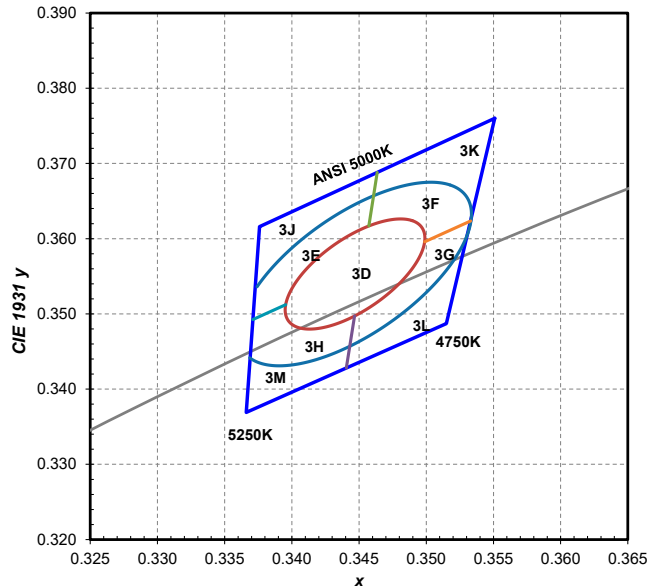

Figure 8f. 1/9<sup>th</sup> color bin structure for LUXEON 2835E and LUXEON 2835C 5000K at specified test current and binning temperatures of  $T_j=25^{\circ}\text{C}$  and  $T_j=85^{\circ}\text{C}$ .

Table 6f. 3- and 5-step MacAdam ellipse color bin definitions for LUXEON 2835E and LUXEON 2835C 5000K, at specified test and binning conditions.

| NOMINAL CCT | COLOR SPACE                   | CENTER POINT <sup>[1]</sup><br>(cx, cy) | MAJOR AXIS,<br>a | MINOR AXIS,<br>b | ELLIPSE ROTATION<br>ANGLE, $\theta$ |
|-------------|-------------------------------|---|------------------|------------------|-------------------------------------|
| 5000K       | Single 3-step MacAdam ellipse | (0.3447, 0.3553)                        | 0.00822          | 0.00354          | 59.62°                              |
| 5000K       | Single 5-step MacAdam ellipse | (0.3447, 0.3553)                        | 0.01370          | 0.00590          | 59.62°                              |

Notes for Table 6f:

1. Lumileds maintains a tolerance of  $\pm 0.007$  on x and y color coordinates in the CIE 1931 color space.

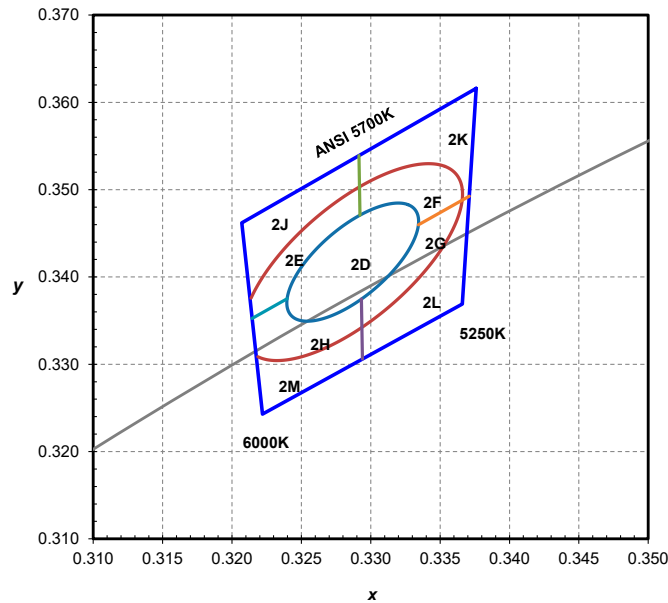

Figure 8g. 1/9<sup>th</sup> color bin structure for LUXEON 2835E and LUXEON 2835C 5700K at specified test current and binning temperatures of  $T_j=25^{\circ}\text{C}$  and  $T_j=85^{\circ}\text{C}$ .

Table 6g. 3- and 5-step MacAdam ellipse color bin definitions for LUXEON 2835E and LUXEON 2835C 5700K, at specified test and binning conditions.

| NOMINAL CCT | COLOR SPACE                   | CENTER POINT <sup>[1]</sup><br>(cx, cy) | MAJOR AXIS,<br>a | MINOR AXIS,<br>b | ELLIPSE ROTATION<br>ANGLE, $\theta$ |
|-------------|-------------------------------|---|------------------|------------------|-------------------------------------|
| 5700K       | Single 3-step MacAdam ellipse | (0.3287, 0.3417)                        | 0.00746          | 0.00320          | 59.09°                              |
| 5700K       | Single 5-step MacAdam ellipse | (0.3287, 0.3417)                        | 0.01243          | 0.00533          | 59.09°                              |

Notes for Table 6g:

1. Lumileds maintains a tolerance of  $\pm 0.007$  on x and y color coordinates in the CIE 1931 color space.



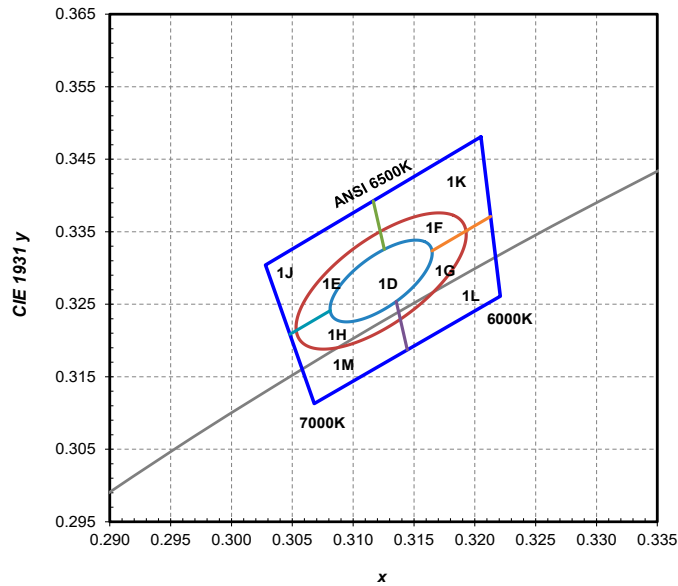

Figure 8h. 1/9<sup>th</sup> color bin structure for LUXEON 2835E and LUXEON 2835C 6500K at specified test current and binning temperatures of  $T_j=25^{\circ}\text{C}$  and  $T_j=85^{\circ}\text{C}$ .

Table 6h. 3- and 5-step MacAdam ellipse color bin definitions for LUXEON 2835E and LUXEON 2835C 6500K, at specified test and binning conditions.

| NOMINAL CCT | COLOR SPACE                   | CENTER POINT <sup>(1)</sup><br>(cx, cy) | MAJOR AXIS,<br>a | MINOR AXIS,<br>b | ELLIPSE ROTATION<br>ANGLE, $\theta$ |
|-------------|-------------------------------|---|------------------|------------------|-------------------------------------|
| 6500K       | Single 3-step MacAdam ellipse | (0.3123, 0.3282)                        | 0.00669          | 0.00285          | 58.57°                              |
| 6500K       | Single 5-step MacAdam ellipse | (0.3123, 0.3282)                        | 0.01115          | 0.00475          | 58.57°                              |

Notes for Table 6h:

1. Lumileds maintains a tolerance of  $\pm 0.007$  on x and y color coordinates in the CIE 1931 color space.

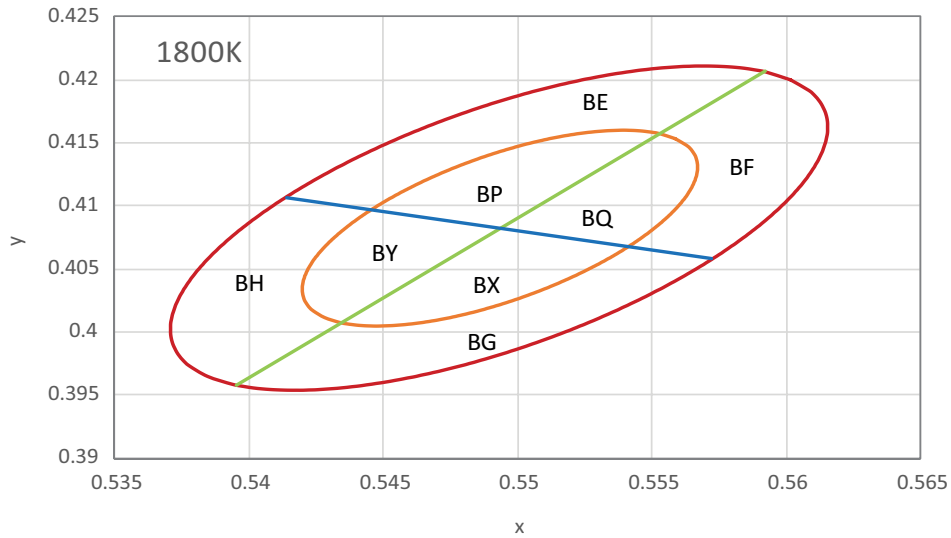

Figure 8i. 1/8<sup>th</sup> color bin structure for LUXEON 2835 HE and LUXEON 2835N 3V 1800K at specified test current and binning temperature of  $T_j=25^{\circ}\text{C}$ .

Table 6i-1. 3- and 5-step MacAdam ellipse color bin definitions for LUXEON 2835 HE and LUXEON 2835N 3V 1800K, at specified test and binning conditions.

| NOMINAL CCT | COLOR SPACE                   | CENTER POINT <sup>(1)</sup><br>(cx, cy) | MAJOR AXIS,<br>a | MINOR AXIS,<br>b | ELLIPSE ROTATION<br>ANGLE, $\theta$ |
|-------------|-------------------------------|---|------------------|------------------|-------------------------------------|
| 1800K       | Single 3-step MacAdam ellipse | (0.5493, 0.4083)                        | 0.00962          | 0.00462          | 47.34°                              |
| 1800K       | Single 5-step MacAdam ellipse | (0.5493, 0.4083)                        | 0.01603          | 0.00770          | 47.34°                              |

Table 6i-2. 4 quadrants definition for LUXEON 2835 HE and LUXEON 2835N 3V 1800K, at specified test and binning conditions.

| POINT  | x      | y      |
|--------|--------|--------|
| 1      | 0.5592 | 0.4207 |
| 2      | 0.5414 | 0.4107 |
| 3      | 0.5395 | 0.3958 |
| 4      | 0.5572 | 0.4058 |
| Center | 0.5493 | 0.4083 |

Notes for Table 6i:

1. Lumileds maintains a tolerance of  $\pm 0.007$  on x and y color coordinates in the CIE 1931 color space.

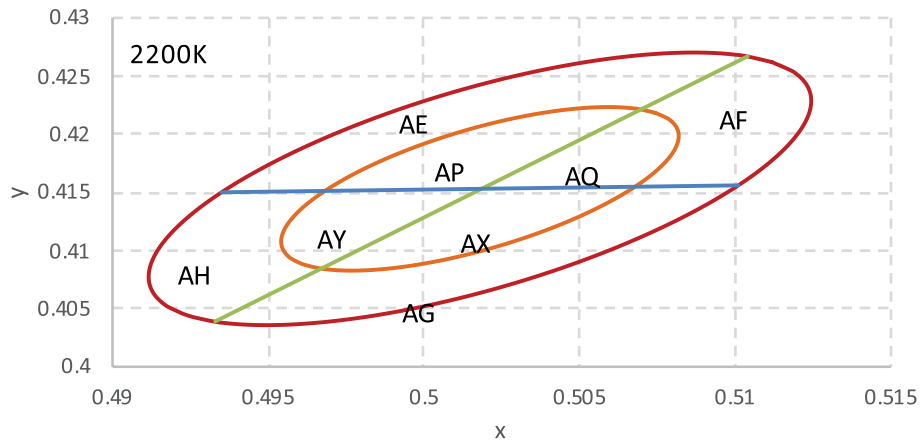

Figure 8j. 1/8<sup>th</sup> color bin structure for LUXEON 2835 HE and LUXEON 2835N 3V 2200K at specified test current and binning temperature of  $T_j=25^{\circ}\text{C}$ .

Table 6j-1. 3- and 5-step MacAdam ellipse color bin definitions for LUXEON 2835 HE and LUXEON 2835N 3V 2200K, at specified test and binning conditions.

| NOMINAL CCT | COLOR SPACE                   | CENTER POINT <sup>(1)</sup><br>(cx, cy) | MAJOR AXIS,<br>a | MINOR AXIS,<br>b | ELLIPSE ROTATION<br>ANGLE, $\theta$ |
|-------------|-------------------------------|---|------------------|------------------|-------------------------------------|
| 2200K       | Single 3-step MacAdam ellipse | (0.5018, 0.4153)                        | 0.00863          | 0.00398          | 49.27°                              |
| 2200K       | Single 5-step MacAdam ellipse | (0.5018, 0.4153)                        | 0.01438          | 0.00663          | 49.27°                              |

Table 6j-2. 4 quadrants definition for LUXEON 2835 HE and LUXEON 2835N 3V 2200K, at specified test and binning conditions.

| POINT  | x      | y      |
|--------|--------|--------|
| 1      | 0.5104 | 0.4267 |
| 2      | 0.4935 | 0.4150 |
| 3      | 0.4933 | 0.4039 |
| 4      | 0.5101 | 0.4156 |
| Center | 0.5018 | 0.4153 |

**Notes for Table 6j:**

1. Lumileds maintains a tolerance of  $\pm 0.007$  on x and y color coordinates in the CIE 1931 color space.

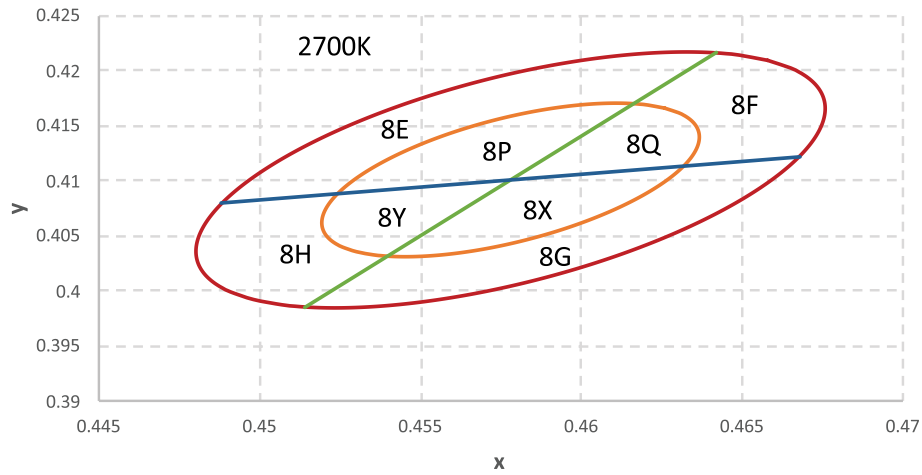

Figure 8k. 1/8<sup>th</sup> color bin structure for LUXEON 2835 HE and LUXEON 2835N 3V 2700K at specified test current and binning temperature of  $T_j=25^{\circ}\text{C}$ .

Table 6k-1. 3- and 5-step MacAdam ellipse color bin definitions for LUXEON 2835 HE and LUXEON 2835N 3V 2700K, at specified test and binning conditions.

| NOMINAL CCT | COLOR SPACE                   | CENTER POINT <sup>[1]</sup><br>(cx, cy) | MAJOR AXIS,<br>a | MINOR AXIS,<br>b | ELLIPSE ROTATION<br>ANGLE, $\theta$ |
|-------------|-------------------------------|---|------------------|------------------|-------------------------------------|
| 2700K       | Single 3-step MacAdam ellipse | (0.4578, 0.4101)                        | 0.00810          | 0.00420          | 53.70°                              |
| 2700K       | Single 5-step MacAdam ellipse | (0.4578, 0.4101)                        | 0.01350          | 0.00700          | 53.70°                              |

Table 6k-2. 4 quadrants definition for LUXEON 2835 HE and LUXEON 2835N 3V 2700K, at specified test and binning conditions.

| POINT  | x      | y      |
|--------|--------|--------|
| 1      | 0.4642 | 0.4217 |
| 2      | 0.4488 | 0.4080 |
| 3      | 0.4514 | 0.3985 |
| 4      | 0.4668 | 0.4122 |
| Center | 0.4578 | 0.4101 |

**Notes for Table 6k:**

1. Lumileds maintains a tolerance of  $\pm 0.007$  on x and y color coordinates in the CIE 1931 color space.

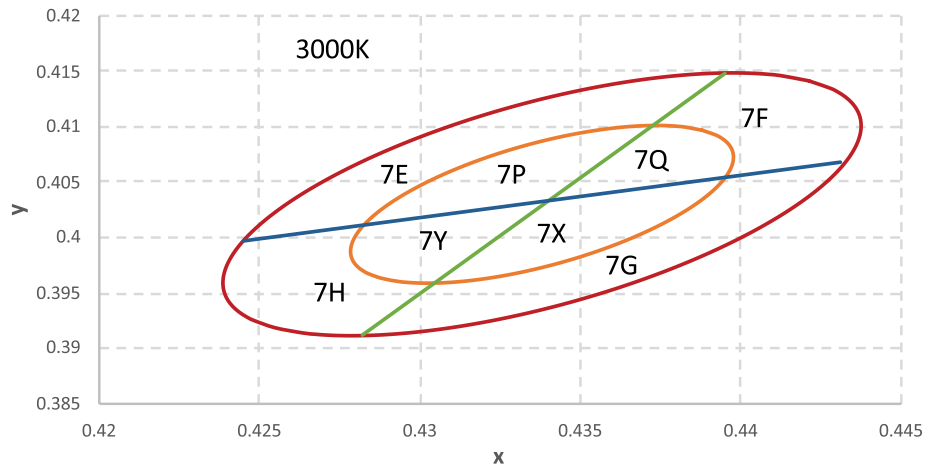

Figure 8I. 1/8<sup>th</sup> color bin structure for LUXEON 2835 HE and LUXEON 2835N 3V 3000K at specified test current and binning temperature of  $T_j=25^{\circ}\text{C}$ .

Table 6I-1. 3- and 5-step MacAdam ellipse color bin definitions for LUXEON 2835 HE and LUXEON 2835N 3V 3000K, at specified test and binning conditions.

| NOMINAL CCT | COLOR SPACE                   | CENTER POINT <sup>(1)</sup><br>(cx, cy) | MAJOR AXIS,<br>a | MINOR AXIS,<br>b | ELLIPSE ROTATION<br>ANGLE, $\theta$ |
|-------------|-------------------------------|---|------------------|------------------|-------------------------------------|
| 3000K       | Single 3-step MacAdam ellipse | (0.4338, 0.4030)                        | 0.00834          | 0.00408          | 53.22°                              |
| 3000K       | Single 5-step MacAdam ellipse | (0.4338, 0.4030)                        | 0.01390          | 0.00680          | 53.22°                              |

Table 6I-2. 4 quadrants definition for LUXEON 2835 HE and LUXEON 2835N 3V 3000K, at specified test and binning conditions.

| POINT  | x      | y      |
|--------|--------|--------|
| 1      | 0.4395 | 0.4148 |
| 2      | 0.4245 | 0.3997 |
| 3      | 0.4282 | 0.3912 |
| 4      | 0.4431 | 0.4062 |
| Center | 0.4338 | 0.4030 |

**Notes for Table 6I:**

1. Lumileds maintains a tolerance of  $\pm 0.007$  on x and y color coordinates in the CIE 1931 color space.

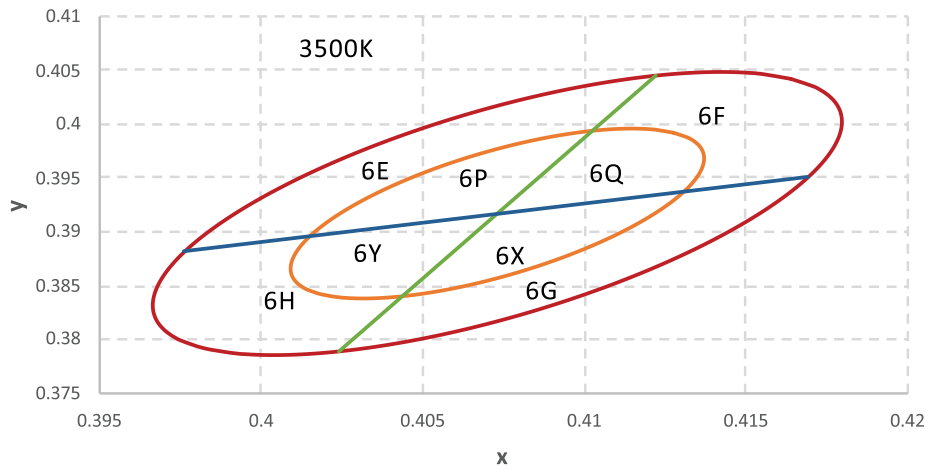

Figure 8m. 1/8<sup>th</sup> color bin structure for LUXEON 2835 HE and LUXEON 2835N 3V 3500K at specified test current and binning temperature of  $T_j=25^{\circ}\text{C}$ .

Table 6m-1. 3- and 5-step MacAdam ellipse color bin definitions for LUXEON 2835 HE and LUXEON 2835N 3V 3500K, at specified test and binning conditions.

| NOMINAL CCT | COLOR SPACE                   | CENTER POINT <sup>(1)</sup><br>(cx, cy) | MAJOR AXIS,<br>a | MINOR AXIS,<br>b | ELLIPSE ROTATION<br>ANGLE, $\theta$ |
|-------------|-------------------------------|---|------------------|------------------|-------------------------------------|
| 3500K       | Single 3-step MacAdam ellipse | (0.4073, 0.3917)                        | 0.00927          | 0.00414          | 54.00°                              |
| 3500K       | Single 5-step MacAdam ellipse | (0.4073, 0.3917)                        | 0.01545          | 0.00690          | 54.00°                              |

Table 6m-2. 4 quadrants definition for LUXEON 2835 HE and LUXEON 2835N 3V 3500K, at specified test and binning conditions.

| POINT  | x      | y      |
|--------|--------|--------|
| 1      | 0.4122 | 0.4045 |
| 2      | 0.3976 | 0.3882 |
| 3      | 0.4024 | 0.3789 |
| 4      | 0.4169 | 0.3951 |
| Center | 0.4073 | 0.3917 |

**Notes for Table 6m:**

1. Lumileds maintains a tolerance of  $\pm 0.007$  on x and y color coordinates in the CIE 1931 color space.

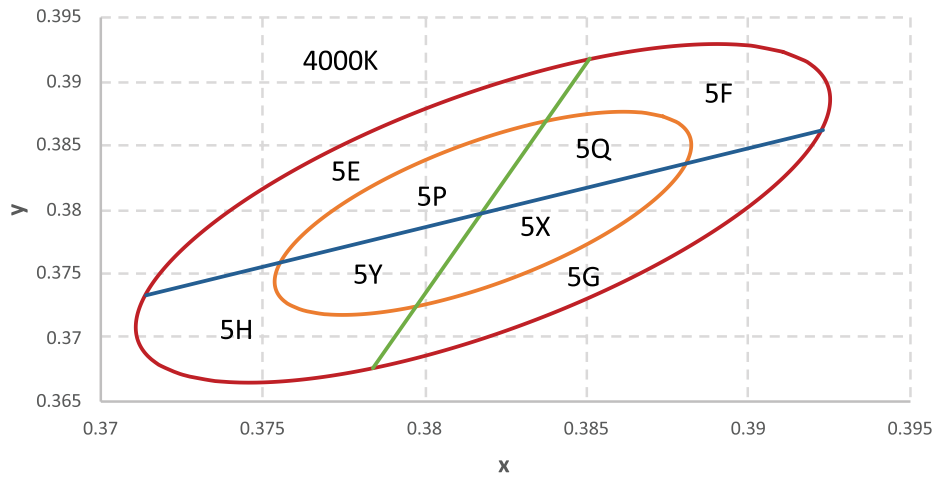

Figure 8n. 1/8<sup>th</sup> color bin structure for LUXEON 2835 HE and LUXEON 2835N 3V 4000K at specified test current and binning temperature of  $T_j=25^{\circ}\text{C}$ .

Table 6n-1. 3- and 5-step MacAdam ellipse color bin definitions for LUXEON 2835 HE and LUXEON 2835N 3V 4000K, at specified test and binning conditions.

| NOMINAL CCT | COLOR SPACE                   | CENTER POINT <sup>[1]</sup><br>(cx, cy) | MAJOR AXIS,<br>a | MINOR AXIS,<br>b | ELLIPSE ROTATION<br>ANGLE, $\theta$ |
|-------------|-------------------------------|---|------------------|------------------|-------------------------------------|
| 4000K       | Single 3-step MacAdam ellipse | (0.3818, 0.3797)                        | 0.00939          | 0.00402          | 53.72°                              |
| 4000K       | Single 5-step MacAdam ellipse | (0.3818, 0.3797)                        | 0.01565          | 0.00670          | 53.72°                              |

Table 6n-2. 4 quadrants definition for LUXEON 2835 HE and LUXEON 2835N 3V 4000K, at specified test and binning conditions.

| POINT  | x      | y      |
|--------|--------|--------|
| 1      | 0.3851 | 0.3918 |
| 2      | 0.3714 | 0.3733 |
| 3      | 0.3784 | 0.3676 |
| 4      | 0.3923 | 0.3862 |
| Center | 0.3818 | 0.3797 |

Notes for Table 6n:

1. Lumileds maintains a tolerance of  $\pm 0.007$  on x and y color coordinates in the CIE 1931 color space.

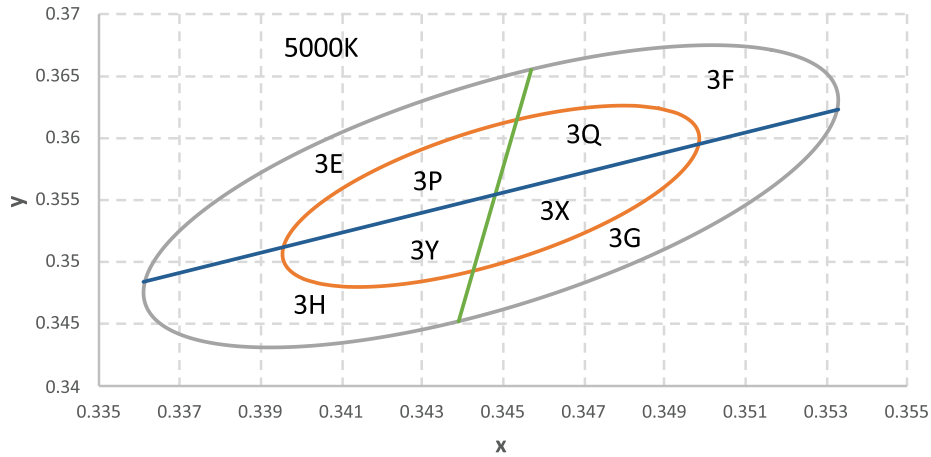

Figure 80. 1/8<sup>th</sup> color bin structure for LUXEON 2835 HE and LUXEON 2835N 3V 5000K at specified test current and binning temperature of  $T_j=25^{\circ}\text{C}$ .

Table 60-1. 3- and 5-step MacAdam ellipse color bin definitions for LUXEON 2835 HE and LUXEON 2835N 3V 5000K, at specified test and binning conditions.

| NOMINAL CCT | COLOR SPACE                   | CENTER POINT <sup>[1]</sup><br>(cx, cy) | MAJOR AXIS,<br>a | MINOR AXIS,<br>b | ELLIPSE ROTATION<br>ANGLE, $\theta$ |
|-------------|-------------------------------|---|------------------|------------------|-------------------------------------|
| 5000K       | Single 3-step MacAdam ellipse | (0.3447, 0.3553)                        | 0.00822          | 0.00354          | 59.62°                              |
| 5000K       | Single 5-step MacAdam ellipse | (0.3447, 0.3553)                        | 0.01370          | 0.00590          | 59.62°                              |

Table 60-2. 4 quadrants definition for LUXEON 2835 HE and LUXEON 2835N 3V 5000K, at specified test and binning conditions.

| POINT  | x      | y      |
|--------|--------|--------|
| 1      | 0.3457 | 0.3655 |
| 2      | 0.3361 | 0.3484 |
| 3      | 0.3439 | 0.3452 |
| 4      | 0.3533 | 0.3623 |
| Center | 0.3447 | 0.3553 |

Notes for Table 60:

1. Lumileds maintains a tolerance of  $\pm 0.007$  on x and y color coordinates in the CIE 1931 color space.



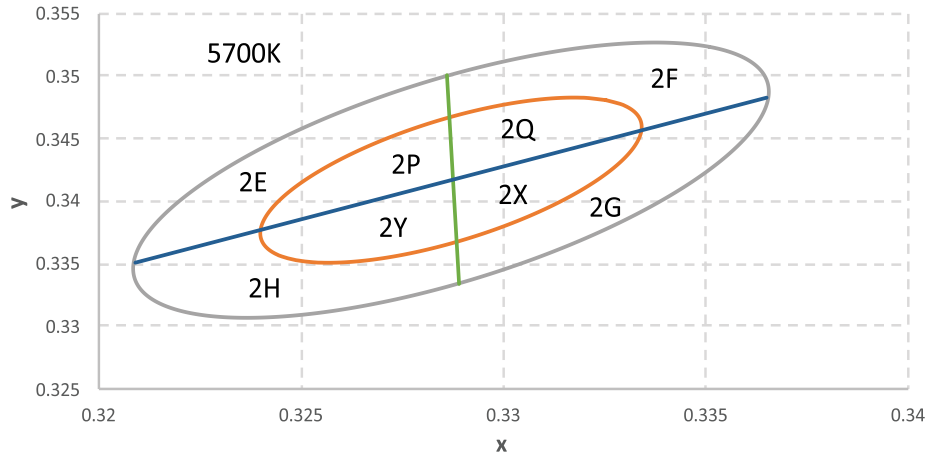

Figure 8p. 1/8<sup>th</sup> color bin structure for LUXEON 2835 HE and LUXEON 2835N 3V 5700K at specified test current and binning temperature of  $T_j=25^{\circ}\text{C}$ .

Table 6p-1. 3- and 5-step MacAdam ellipse color bin definitions for LUXEON 2835 HE and LUXEON 2835N 3V 5700K, at specified test and binning conditions.

| NOMINAL CCT | COLOR SPACE                   | CENTER POINT <sup>(1)</sup><br>(cx, cy) | MAJOR AXIS,<br>a | MINOR AXIS,<br>b | ELLIPSE ROTATION<br>ANGLE, $\theta$ |
|-------------|-------------------------------|---|------------------|------------------|-------------------------------------|
| 5700K       | Single 3-step MacAdam ellipse | (0.3287, 0.3417)                        | 0.00746          | 0.00320          | 59.09°                              |
| 5700K       | Single 5-step MacAdam ellipse | (0.3287, 0.3417)                        | 0.01243          | 0.00533          | 59.09°                              |

Table 6p-2. 4 quadrants definition for LUXEON 2835 HE and LUXEON 2835N 3V 5700K, at specified test and binning conditions.

| POINT  | x      | y      |
|--------|--------|--------|
| 1      | 0.3286 | 0.3501 |
| 2      | 0.3209 | 0.3351 |
| 3      | 0.3289 | 0.3334 |
| 4      | 0.3365 | 0.3483 |
| Center | 0.3287 | 0.3417 |

**Notes for Table 6p:**

1. Lumileds maintains a tolerance of  $\pm 0.007$  on x and y color coordinates in the CIE 1931 color space.

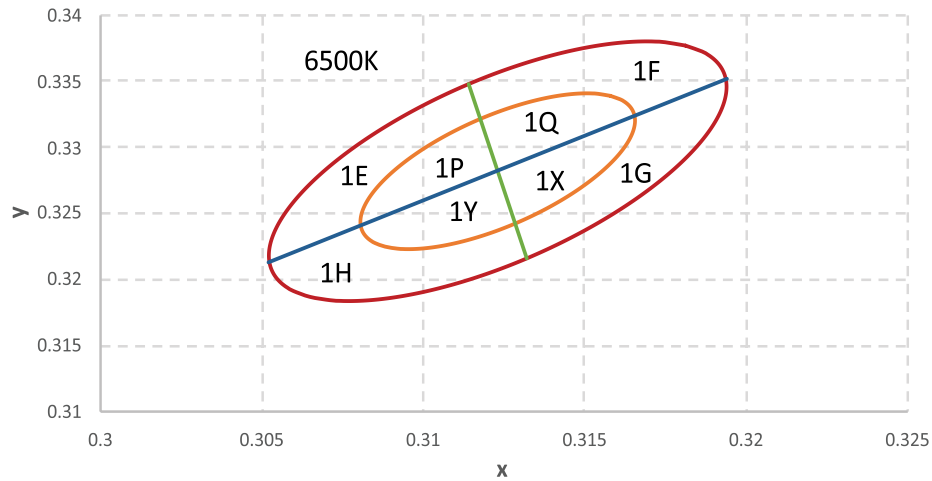

Figure 8q. 1/8<sup>th</sup> color bin structure for LUXEON 2835 HE and LUXEON 2835N 3V 6500K at specified test current and binning temperature of  $T_j=25^{\circ}\text{C}$ .

Table 6q-1. 3- and 5-step MacAdam ellipse color bin definitions for LUXEON 2835 HE and LUXEON 2835N 3V 6500K, at specified test and binning conditions.

| NOMINAL CCT | COLOR SPACE                   | CENTER POINT <sup>(1)</sup><br>(cx, cy) | MAJOR AXIS,<br>a | MINOR AXIS,<br>b | ELLIPSE ROTATION<br>ANGLE, $\theta$ |
|-------------|-------------------------------|---|------------------|------------------|-------------------------------------|
| 6500K       | Single 3-step MacAdam ellipse | (0.3123, 0.3282)                        | 0.00669          | 0.00285          | 58.57°                              |
| 6500K       | Single 5-step MacAdam ellipse | (0.3123, 0.3282)                        | 0.01115          | 0.00475          | 58.57°                              |

Table 6q-2. 4 quadrants definition for LUXEON 2835 HE and LUXEON 2835N 3V 6500K, at specified test and binning conditions.

| POINT  | x      | y      |
|--------|--------|--------|
| 1      | 0.3114 | 0.3348 |
| 2      | 0.3052 | 0.3213 |
| 3      | 0.3132 | 0.3216 |
| 4      | 0.3194 | 0.3352 |
| Center | 0.3123 | 0.3282 |

Notes for Table 6q:

- Lumileds maintains a tolerance of  $\pm 0.007$  on x and y color coordinates in the CIE 1931 color space.

## Forward Voltage Bins

Table 7. Forward voltage bin definitions for LUXEON 2835 Architectural at specified test current,  $T_j=25^{\circ}\text{C}$ .

| PRODUCT   | BIN | FORWARD VOLTAGE <sup>(1)</sup> (V <sub>f</sub> ) |         |
|---|-----|--|---------|
|   |     | MINIMUM  | MAXIMUM |
| LUXEON 2835E 9V   | U   | 8.40   | 8.70    |
|   | V   | 8.70   | 9.00    |
|   | W   | 9.00   | 9.30    |
|   | X   | 9.30   | 9.60    |
|   | Y   | 9.60   | 9.90    |
| LUXEON 2835E 6V   | U   | 5.60   | 5.80    |
|   | V   | 5.80   | 6.00    |
|   | W   | 6.00   | 6.20    |
|   | X   | 6.20   | 6.40    |
|   | Y   | 6.40   | 6.60    |
| LUXEON 2835C 6V   | G   | 5.80   | 6.00    |
|   | H   | 6.00   | 6.20    |
|   | J   | 6.20   | 6.40    |
|   | K   | 6.40   | 6.60    |
| LUXEON 2835E 3V<br>LUXEON 2835C 3V<br>LUXEON 2835C 3V TVS | S   | 2.70   | 2.80    |
|   | T   | 2.80   | 2.90    |
|   | V   | 2.90   | 3.00    |
|   | W   | 3.00   | 3.10    |
|   | X   | 3.10   | 3.20    |
| LUXEON 2835 HE 3V   | Y   | 3.20   | 3.30    |
|   | K   | 2.66   | 2.76    |
| LUXEON 2835N 3V   | Q   | 2.68   | 2.78    |
|   | R   | 2.78   | 2.88    |

**Notes for Table 7:**

1. Lumileds maintains a tolerance of  $\pm 0.10\text{V}$  on forward voltage measurements.

# Mechanical Dimensions

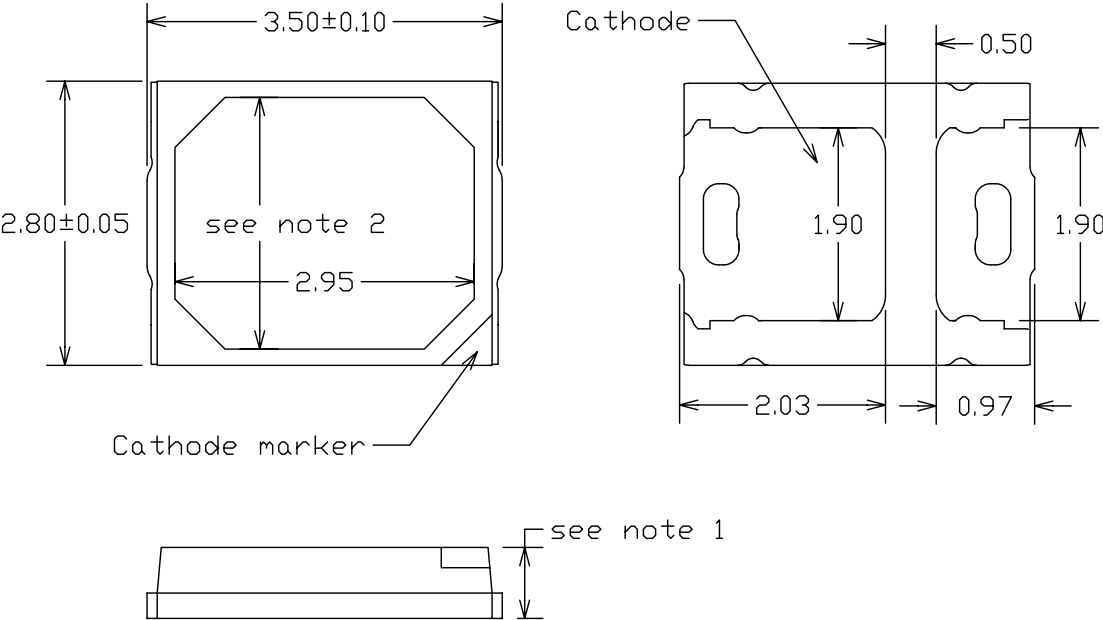

|        | LUXEON 2835E<br>3V | All Others  |
|--------|--------------------|-------------|
| note 1 | 0.65 ± 0.05        | 0.70 ± 0.05 |
| note 2 | 2.53               | 2.48        |

Figure 9. Mechanical dimensions for LUXEON 2835 Architectural.

Notes for Figure 9:  
 1. Drawings are not to scale.  
 2. All dimensions are in millimeters.

# Reflow Soldering Guidelines

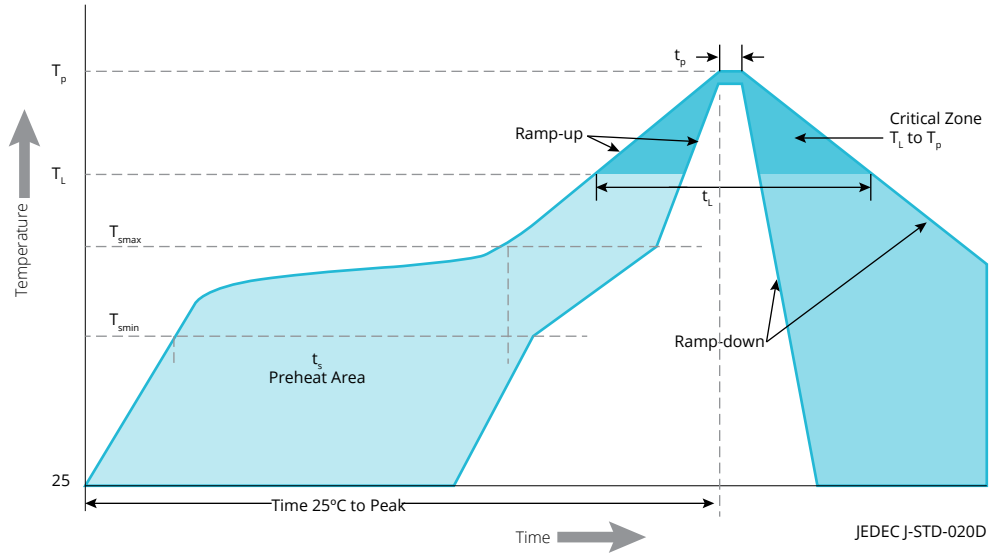

Figure 10. Visualization of the acceptable reflow temperature profile as specified in Table 8.

Table 8. Reflow profile characteristics for LUXEON 2835 Architectural.

| PROFILE FEATURE                                   | LEAD-FREE ASSEMBLY   |
|---|----------------------|
| Preheat Minimum Temperature ( $T_{smin}$ )        | 150°C                |
| Preheat Maximum Temperature ( $T_{smax}$ )        | 200°C                |
| Preheat Time ( $t_{smin}$ to $t_{smax}$ )         | 60 to 120 seconds    |
| Ramp-Up Rate ( $T_L$ to $T_p$ )                   | 3°C / second maximum |
| Liquidus Temperature ( $T_L$ )                    | 217°C                |
| Time Maintained Above Temperature $T_L$ ( $t_L$ ) | 60 to 150 seconds    |
| Peak / Classification Temperature ( $T_p$ )       | 260°C                |
| Time Within 5°C of Actual Temperature ( $t_p$ )   | 20 to 40 seconds     |
| Ramp-Down Rate ( $T_p$ to $T_L$ )                 | 6°C / second maximum |
| Time 25°C to Peak Temperature                     | 8 minutes maximum    |

## JEDEC Moisture Sensitivity

Table 9. Moisture sensitivity levels for LUXEON 2835 Architectural.

| LEVEL | FLOOR LIFE |                | SOAK REQUIREMENTS STANDARD |               |
|-------|------------|----------------|----------------------------|---------------|
|       | TIME       | CONDITIONS     | TIME                       | CONDITIONS    |
| 3     | 168 Hours  | ≤30°C / 60% RH | 192 Hours +5 / -0          | 30°C / 60% RH |



# Reel Dimensions

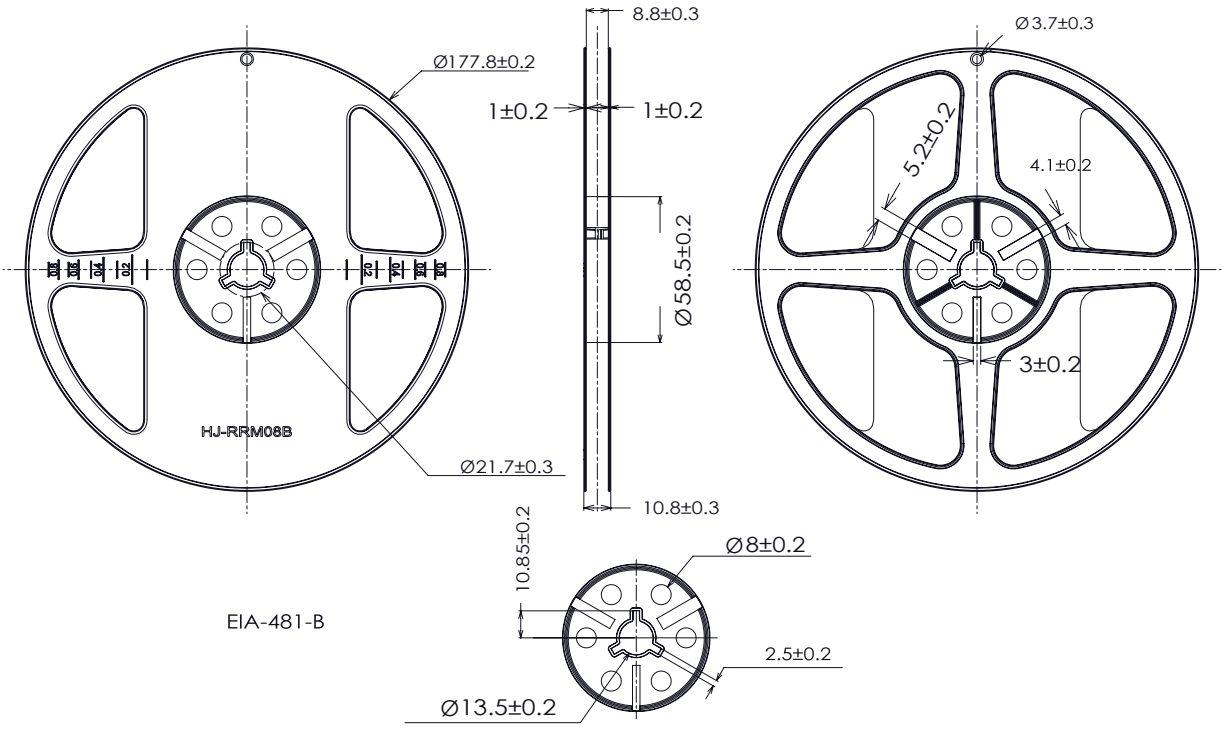

Figure 13. Reel dimensions for LUXEON 2835 Architectural.

- Notes for Figure 13:
1. Drawings are not to scale.
  2. All dimensions are in millimeters.

## About Lumileds

Companies developing automotive, mobile, IoT and illumination lighting applications need a partner who can collaborate with them to push the boundaries of light. With over 100 years of inventions and industry firsts, Lumileds is a global lighting solutions company that helps customers around the world deliver differentiated solutions to gain and maintain a competitive edge. As the inventor of Xenon technology, a pioneer in halogen lighting and the leader in high performance LEDs, Lumileds builds innovation, quality and reliability into its technology, products and every customer engagement. Together with its customers, Lumileds is making the world better, safer, more beautiful—with light.

To learn more about our lighting solutions, visit [lumileds.com](http://lumileds.com).



©2023 Lumileds Holding B.V. All rights reserved.  
LUXEON is a registered trademark of the Lumileds Holding B.V. in the United States and other countries.

[lumileds.com](http://lumileds.com)

Neither Lumileds Holding B.V. nor its affiliates shall be liable for any kind of loss of data or any other damages, direct, indirect or consequential, resulting from the use of the provided information and data. Although Lumileds Holding B.V. and/or its affiliates have attempted to provide the most accurate information and data, the materials and services information and data are provided "as is," and neither Lumileds Holding B.V. nor its affiliates warrants or guarantees the contents and correctness of the provided information and data. Lumileds Holding B.V. and its affiliates reserve the right to make changes without notice. You as user agree to this disclaimer and user agreement with the download or use of the provided materials, information and data. A listing of Lumileds product/patent coverage may be accessed at [lumileds.com/patents](http://lumileds.com/patents).